

**00761**

1963/03/22

Proceedings  
of the  
Special Projects Office

Task II - Monitor and Sponsor the Fleet Ballistic  
Missile Development Program

36th Meeting - 21, 22 March, 1963

This document contains information affecting the national defense of the United States within the meaning of the Espionage Laws, Title 18, U.S.C., Section 793 and 794. The transmission or the revelation of its contents in any manner to an unauthorized person is prohibited by law.

Prepared by:

*Clayton E. Green*  
Technical Secretary

Reviewed by:

*W. H. ...*  
Executive Secretary

Approved by:

*Levin Smith*  
Chairman

Declassified on 16 March 1995 in  
accordance with OPNAVINST 5513.5B  
Enclosure (27).

950  
20 APR 1963

## TABLE OF CONTENTS

Introduction . . . . .	1
Missile Committee Report Discussion . . . . .	7
Re-entry Body Committee Report Discussion . . . . .	35
Fire Control & Guidance Committee	
Report Discussion . . . . .	65
Mr. Mitchell . . . . .	76
Launching Committee Report Discussion . . . . .	81
Command Communications Committee	
Report Discussion . . . . .	101
Submarine Design Committee Report Discussion . . . . .	107
Navigation Committee Report Discussion . . . . .	129
Systems Appraisal Committee Report Discussion . . . . .	147

## INTRODUCTION

In place of his own introductory remarks, Admiral Smith introduced Admiral Galantin.

"This particular room has been a very busy scene in the last few weeks," began Admiral Galantin, "because of our negotiations with the British. Admiral Mott was actually the senior negotiator and we have now completed the basic sales agreement for the UK/POLARIS program, but the agreement has to be referred to the two governments because it has no standing at the Ministerial and Secretarial level until approved.

"The British negotiators and Captain Rudden, as my senior representative, have come up with an agreement that seems eminently feasible and acceptable to both sides at our level, but now it must go back for top-level approval. The agreement initially calls for building four SSB(N)'s in Britain; two will be built by Vickers and the other two by one or more additional shipbuilders.

"A basic principle in the whole agreement is that the British will buy the complete weapon system from us. The British intend to have the first ship operational early in (the) 1968. If they build the ship and provide specified components, then these will be essentially follow-on items and will be just additional procurement in our own program.

## INTRODUCTION

"We are hopeful that the agreement will be signed and sealed very soon in order that we may inform some of the people on our team of the task that is to be done. Meanwhile, the Admiralty is going ahead in assembling its organization, confident that the program will proceed very smartly.

"The parallel development of the multi-lateral force is nowhere near as far along as the British negotiations. The newspapers indicate how controversial this issue is. Achieving European agreement that a surface-based POLARIS system is as good as we say it is will be difficult, but we know it could be a quite efficient system if properly operated. Basically it comes down to the fact that this kind of fleet could be procured more quickly and somewhat more cheaply than a submarine system, and the manning problems would not be so severe. This issue is still in the discussion stage and in the realm of foreign and defense policy, so I cannot be more specific. I can only remind those of you involved in production that this too is to be a government-to-government program.

"We have received from the Office of the Secretary of Defense a directive to restudy our A2 procurement program with the possible objective of economizing. To this effect, the Secretary asks if the operational problem would be satisfied should additional A2 missiles be procured and the A2 be retained in 13 submarines with the A3 in 28.

"We are investigating the question and pointing out what is involved. Such a plan would incur some additional costs in the extra tooling needed to continue the A2 production.

"The decision to proceed with the retrofit of those first five boats in the 598-Class is now clear. We have been trying to get this decision for a long time and we will go ahead with the retrofit. The A2 will be passed over and the 598-Class will be outfitted to receive the A3; the first of those boats will be the USS GEORGE WASHINGTON.

## INTRODUCTION

"I would like to discuss our ORRT program. If you remember the tests, four missiles per operational submarine were fired. The USS GEORGE WASHINGTON had two proven successes out of her four. There is a question that one of the other missiles may have been more successful than we think, but we can only claim two.

"In the SSB(N)599 tests that followed, we ran into considerable difficulties. These tests were conducted during the rough weather period, but that did not in itself create the problem. Out of her four shots only one was effective. It was an accurate shot, but the only one out of four. More serious than that, however, is the fact that it took a long time to get these four shots off; in fact, it took over 24 hours because of some problems in the launching and the countdown of the missile, including some range trouble and an overnight wait. This 24-hour period does not represent a continuous attempt to fire. Nevertheless the SSB(N)599 was not able to respond on the immediacy of its readiness requirement.

"As a result of that experience, we accelerated our examination of what is happening to the A1 in the Fleet. We have known that there is some degradation with time of some elements; there also seems to be a growth in the separation of propellant from the case and a degradation in some of the rubber goods and electrical appurtenances.

"The effect of this examination was that we had a program to update these missiles, and we conducted a very searching analysis of everything connected with this including the training of the crew, the launch procedure, and the missiles themselves. What we now have in effect is a recertification program, a program that was already in vogue, but has now been accelerated so that by this August all the deployed A1 submarines will be outfitted with recertified A1 missiles. They have been called back, radiographed, checked for evidence of unacceptable separation, and examined to ensure that any work done in the Fleet on these missiles has been thoroughly checked out. By August we will have a new standard for these missiles and a much more reliable set of deployed missiles.

## INTRODUCTION

"After the experience of firing four shots with only one success, the USS THEODORE ROOSEVELT was sent out with these recertified missiles and was instructed to shoot as many as four, but to stop when she got two successes. The first shot was fully successful; the second was not; and the third was successful. Two out of three shots were completely successful both in time of firing, accuracy and so on, so we are back to battery on this.

"I think that we are well on top of this situation, but I would like to mention what effect this may have on the retrofit of the 598-Class. We now know that deployed missiles need very close scrutiny and that our training must be constantly kept alive. We are looking at the 598-Class retrofit to see if it might be desirable to accelerate the schedule and in this way introduce into the Fleet an A3 which would be more reliable, hopefully, than the A1 is at that time. This plan has to be examined very critically because we do not want an 'out of the frying pan into the fire' situation here. By that time we will have a much higher level of confidence in the A1 because of the greater number of firings, whereas the A3 will certainly be in its deployed infancy. For these reasons we are not being stampeded into anything and we are looking at it critically with continuing emphasis on system reliability -- not just in-flight reliability -- but the launch reliability and all the other aspects that go with it. This problem is not peculiar to POLARIS. While we have better performance and reliability than other systems, we must work to keep it that way, and we will all admit that the A1 is not our most reliable missile.

---

"The measures we are taking will bring the A1 to a quite respectable level of at least 50 per cent system reliability with a high level of confidence because of the greater number of firings we will be doing. In the later missiles, the A2 and A3, we will increase that level of reliability well beyond 50 per cent.

## INTRODUCTION

"I think you may have learned from other sources that on 10 and 11 April we are having our Third POLARIS-Industry Team Conference at Annapolis. We hope that the environment, well removed from the pressures of Washington, will give us a chance to accomplish a little more in the very compressed schedule we are going to have.

"The Secretary, Mr. Korth, will introduce the meeting and Mr. Paul Fay, the Undersecretary, will speak on the second morning. I was hopeful that Admiral Dennison could be with us too and give us the benefit of his experience as the operational commander. Unfortunately, he regrets that he cannot be present. He tells me that, since he is retiring on 30 April, the very pressures of his own relief make it impossible for him to come to Annapolis for this meeting, but he will send a very fine representative. I think Admiral Grenfell will probably be with us to tell us where we are meeting their requirements and where we might be falling short."

This concluded Admiral Galantin's opening remarks, and Admiral Smith then introduced Captain Dobyk for the Missile Committee Report.



## MISSILE COMMITTEE REPORT DISCUSSION

Before Captain Dubyk commenced his report, Admiral Smith noted a change in the minutes to the previous Steering Task Group meeting, explaining that the change had already been promulgated to the Committee members.

"I am anxious to speak today," began Captain Dubyk. "because there is some encouraging news about the A3 range situation. The flights we had on the A3X-7 and A3X-8 indicated that there has been an element of conservatism in the range calculations: we have either assumed a low impulse or have not taken all the inert weight burnout into account.

"To pinpoint the discrepancy, we have reviewed static firing data, actual inert weights and propellant weights; we have reviewed also the adjustments for flight degradation on the A1 and A2; these might be applicable to the A3."

Answering a question from Admiral Smith, Captain Dubyk explained that the range predictions were made on the basis of static firing data and corrections to the static firing data. "As an example," he said, "one of the things we assumed was that we were not getting as much burnout as actually occurs. Our basic information is based on static firing data taken from thrust-time information, static load cells and the actual flight situation was extracted from these data."

## MISSILE COMMITTEE DISCUSSION

"Would the initial estimates have been any closer if each of the motor developers had used static firing stands of the type that NOTS had been working on to get a running determination of specific impulse?" Admiral Smith asked.

"I do not know of the experience of all the contractors," said Dr. Wetmore, "but in our case and also at ABL, the only weight change that has been considered is the loss in propellant weight which occurs during the firing. Loss of other materials in the past has never been considered. The average inert weight would be less than the starting weight, however, and the best way to measure this quantity is to weigh the motor before and after firing to determine the total inert weight loss.

"Weighing a motor during firing," he continued, "is a problem of such magnitude that the  $I_{sp}$  cannot be determined instantaneously. We have never been able to estimate these specific impulses accurately. The figure that we are using from the flight test, however, is not dependent on an instantaneous estimate; it is essentially the total inert weight after firing.

"This question of inert weight loss has been an uncertainty since inception of the program and ABL has been stressing for some time that there will be a range gain from this loss, particularly in the second stage."

"What I am interested in," said Admiral Smith, "is whether this range advantage has to be proved by flight testing."

"There has been quite a bit of difference in opinion about this, matter," said Captain Dubyk. "The propulsion people have been insisting right along that they were not getting enough credit for this weight loss."

## MISSILE COMMITTEE DISCUSSION

---

Mr. Fuhrman pointed out that the difficulty in assessing the gain by loss of inert weight stemmed from a problem which developed during the first part of the A2 program where a fairly optimistic rate of inert burnout was assumed but never actually occurred in flight. The burnout rate in that case was assumed to be linear with time, but it turned out to be exponential with time and the early rate of burnout was very low."

"This is the reason I feel we need data during burning," said Admiral Smith, "because if weight after firing is the only determination, all that will be known is the final end point weight."

"ABL conducted several firings during their insulation development program when the burning was stopped during the firing at various times," Mr. Fuhrman observed. "It was learned during these tests that the weight loss estimate was conservative."

"To answer the Admiral's first question," he continued, "I am not too familiar with the situation at NOTS, but in our case, the accuracy is not enough to warrant the extra time and money involved. It is just not possible to get accurate enough data during firing; it is possible on small laboratory type motors, but not on the big motors."

"Figure 1 depicts the current  $I_{sp}$  and burnout situation and compares it with the situation as predicted in last June's STG meeting," said Captain Dubyk.

	STG $I_{sp}$	STG Inert Burnout	Current $I_{sp}$	Current Burnout	Range
1st	260.0	0	260.5	250	17
2nd	274.5	50	276.8	130	77

Figure 1

## MISSILE COMMITTEE DISCUSSION

"Regarding the first stage range increase, the additional  $I_{sp}$  contributes 6.8 miles to the total gain in range. Inert weight contribution is a linear situation and therefore, not applicable. To figure the range increase resulting from the 250-pound loss, the figure was divided by three and multiplied by the range decrement for inert weight loss which is 0.14 pound per mile. This weight then, contributes 10 miles to the total 17-mile gain.

"The first stage gains, of course, are not very large. Gains become much more significant on the second stage. There, the contribution for every 1 per cent increase in  $I_{sp}$  is 53.7 miles. The difference here is 2.3 per cent and that equals 45 of the 77 miles. The increase due to the additional 80-pound inert weight burnout using a linear approach contributes 32 miles."

"Is that figure based on more than one flight test?" asked Admiral Smith.

"The figures are based on the two flight tests, A3X-7 and A3X-8 plus the data from the ABL static firings and post-firing examination on the two flights," answered Captain Dubyk.

Captain Sanger asked whether these were optimistic or pessimistic estimates of the range increase and Captain Dubyk explained that the estimates were probably slightly on the pessimistic side because dividing the burnout increase by three probably was a conservative approach.

"Our best estimate of the situation is that the effect of  $I_{sp}$  on range might be  $\pm 1$  of the estimated figure," Captain Dubyk said. "On the first stage I do not think that it would vary more than a few tenths of a point, but on the second stage it might quite easily be  $\pm 1$  point. On the inert weight burnout I feel that the amount of burnout probably is not going to change much but the rate of burnout may change. This difference may have a 10- or 15-mile effect on range."

## MISSILE COMMITTEE DISCUSSION

"Could you put some upper and lower limits on this total range increase?" asked Captain Sanger.

"I would say a minimum gain of 60 miles and a maximum gain of 130 miles," said Mr. Fuhrman.

"We plan to use these range improvements in our discussions," Captain Dubyk explained. "The range improvements will undoubtedly change from time to time as more flight information is obtained, but the +17 miles is probably not going to be too sensitive unless it sees an extreme variation. The 77-mile increase in the second stage is more likely to change, but I think a minimum 60 miles increase is about as low as we will possibly go.

"Figure 2 is a summary of the weight changes and status for the A3P missile. Figure 3 summarizes weight and range status for all A3 models. On the first stage propellant, the original estimate from June of last year has been increased by 16 pounds for a current weight of 20,816 pounds. This weight is for the A3 and does not include the 415 pounds of instrumentation associated with the A3X or A3E flights. This 16-pound increase is an actual weight based on the SECOR motors which will be introduced with the A3X-12 flight.

"The inert weights have increased 99 pounds from 3040 to 3139 pounds. Most of this increase has been in the nozzles which turned out to be heavier than expected. The ballistic shell weight has also increased by 10 pounds from the original 116-pound estimate. An addition of brackets in the interstage to take separation and underwater launch loads resulted in a weight increase, but the flight controls have decreased 9 pounds. The electrical system has not changed.

"Except for the rather substantial increase attributed to increases in inert weight, the estimates have been fairly accurate in the first stage.

MISSILE COMMITTEE DISCUSSION

POLARIS A3 PERFORMANCE STATUS					19 MARCH 1963
Item	STG	Sep 1962	Dec 1962	Mar 1963	Current Status
	Jun 1962				
1st Stage	24242	+141	-108	+113	24358
Propulsion	23840	+52	+125	+115	23955
Propellant	20800	0	+21	+116	20816
Inert	3040	+52	+104	+99	3139
I <sub>T</sub> X 10 <sup>6</sup>	5.406	+0.002	+0.007	+0.020	5.426
Ballistic Shell	116	+2	+1	+10	126
Flight Control	172	-12	-16	-9	163
Electrical	114	-1	-2	0	114
2nd Stage	10305	-15	-1	+50	10355
Propulsion	9536	+9	-1	-36	9500
Propellant	8876	+4	-11	-32	8844
Inert	610	+7	+10	+11	621
Potting Compound	50	0	0	-15	35
I <sub>T</sub> X 10 <sup>6</sup>	2.436	-0.014	+0.004	+0.012	2.448
Ballistic Shell	260	+9	0	+6	266
Nose Fairing	137	+8	+3	+3	140
Equipment Section	123	+1	-3	+3	126
Flight Controls	323	+4	+22	+24	347
Electrical	88	-5	-5	+11	99
Guidance	80	+1	+1	+1	81
Cont. & Trim	18	-6	-18	+34	52
Re-entry System	1050	+23	+34	+30	1080
Basic R/S	1023	+20	+25	+19	1042
Heat Shield	27	-3	+9	+11	38
PX-2/PY-2	246	+20	+14	+22	268
R/S	228	+14	+4	+17	245
Electrical	18	0	+4	-1	17
PY-2	0	+6	+6	+6	6
Missile Gross					
With PX/PY	35843	+98	+155	+218	36061
Without PX/PY	35597	+78	+155	+178	35775
Range					
With PX/PY	2160	-14	-10	-10	2150
Without PX/PY	2500	-75	-50	-8	2492

Figure 2

# MISSILE COMMITTEE DISCUSSION

## POLARIS A3 PERFORMANCE STATUS      19 MARCH 1963

ITEM	STG	CURRENT STATUS		
	Jun 1962	A3P	A3X-11	A3E
1st Stage	24242	24358	23980	24380
Propulsion	23840	23455	23587	23955
Propellant	20800	20816	20509	20816
Inert	3040	3139	3078	3139
Isp	260.0	260.5	260.0	260.5
I <sub>T</sub> X 10 <sup>6</sup>	5.406	5.426	5.340	5.426
Ballistic Shell	116	126	122	126
Flight Controls	172	163	164	163
Electrical	114	114	107	114
Exercise/ORRT	---	---	---	19
2nd Stage	10305	10355	10460	10517
Propulsion	9536	9500	9544	9500
Propellant	8876	8844	8832	8844
Inert	610	621	662	621
Potting Compound	50	35	50	35
Isp	274.5	276.8	275.4	276.8
I <sub>T</sub> X 10 <sup>6</sup>	2.440	2.448	2.432	2.448
Ballistic Shell	260	266	267	266
Nose Fairing	137	140	140	140
Equipment Section	123	126	127	126
Flight Controls	323	347	477	347
Electrical	88	99	88	99
Guidance	80	81	84	81
Contingency and Trim	18	52	0	12
Exercise/ORRT	--	--	--	182
Re-entry System	1050	1080	1192	1080
Basic R/S	1023	1042	1120	1042
Heat Shield	27	38	72	38
PX-2/PY-2	246	268	---	---
R/S	228	245	---	---
Electrical	18	17	---	---
PY-2	0	6	---	---
Instrumentation Weight	--	--	417	201
1st Stage	--	--	71	19
2nd Stage	--	--	346	182
Missile Gross Weight				
With PX/PY	35843	36061		
Without PX/PY	35597	35775	35534*	35974
Range I				
With PX/PY	2160	2150		
Without PX/PY	2500	2492	2360*	2275

\*Without instrumentation, i. e., equivalent tactical version.

Figure 3

## MISSILE COMMITTEE DISCUSSION

"In the second stage the propellant weight has gone down 32 pounds -- again a situation where the weights are based on actual values. The main reason for this decreased propellant weight is that the insulation is thicker than planned. At the previous meeting, this point was discussed and it was decided that rather than going into the very substantial effort required to change the material and retest it, we will keep using the present insulation, the actual weight of which appears to be between 157 and 162 pounds. This thicker, denser insulation accounts for an 11-pound increase in the inert weight.

"The potting weight is being reduced from 50 to 35 pounds; this is a scheduled change which will be tested in the A3X-18. The static firings have indicated that eliminating this potting will be a safe change.

"The second stage thrust has gone up by 0.012 to a new value. This change is tied in primarily with the  $I_{sp}$  increase that has been discussed before combined with slightly less propellant.

"We have actual weights for the nose fairing and the equipment section. The increase in the nose fairing weight is attributable to the fact that the glue was a little heavier than anticipated. In the equipment section the flight controls show that a very substantial increase of 24 pounds was incurred. Fourteen pounds of this 24 is due to use of the older style rubber bladder in the Mod 2 thrust vector control system. As discussed in the last STG meeting, it is possible to use a lighter metal ballonet in this system but the Group felt at that time that the development program associated with the change would be sufficiently complicated to make the change undesirable. The assurance that we have with a heavier bladder was worth the extra weight; thus, 14 of the 24 pounds are caused by use of this bladder. Ten pounds of the increase result from heat protection which is going to be required on the Mod 2 thrust vector control system.

"The second stage electrical weight is 11 pounds greater than planned due to the standard firing units that will be used. These firings



## MISSILE COMMITTEE DISCUSSION

units have been standardized throughout the missile and are being designed at Lockheed. They will be more reliable and certainly will make the maintaining of this system much easier since the accessibility will be much improved. Associated with the increase in second-stage electrical weight, we have had increases due to the pads put in for the guidance system. These occasioned a one-pound increase and it probably is not critical at the moment. This figure again is an actual weight. Due to this one change, we now have a contingency of 52 pounds."

"How much of that is contingency and how much is planned for trim?" asked Admiral Smith.

"About 14 pounds is for trim," answered Captain Dubyk.

"At present there are four pounds of trim ballast with the PX-2 and 14 pounds without it," Mr. Fuhrman stated.

"Why has the trim increased since last December?" asked Admiral Smith.

Dr. Wilson answered, "There is a tradeoff between trim requirement and fluid requirement because if the missile is balanced by trim, less fluid is needed to correct for roll caused by unbalance. Similarly, if excess fluid for TVC is carried it can correct for unbalance and therefore not require trim weights."

"I would like to point out," continued Captain Dubyk, "that the contingency figure was derived from the increases in  $I_{sp}$ . We arbitrarily chose 2150 miles as the range because it is well above the rock-bottom minimum and used the differences in  $I_{sp}$  to increase the contingency. The range could be increased if we do not need that contingency, but with the flight test problems still ahead, it is a good anchor point to stay well above the minimum.

## MISSILE COMMITTEE DISCUSSION

"Re-entry system increases have totaled 19 pounds above the June estimated weight of 1023 pounds. Twelve pounds of the additional weight is in the local heat protection area on the re-entry system. While further flight test information is needed to determine the heat environment, the initial tests have shown that there are some hot spots in the re-entry area.

"The A3X-7 produced some particularly good flight test data and showed that Lockheed was being overly pessimistic on the heating problem in some spots, but in others the heat environment was as bad as had been predicted.

"Of this re-entry system weight increase, 12 pounds was attributed to the heat protection and 5 pounds to AEC changes."

"Why is the total still less than the December weight estimate for the re-entry system?" asked Admiral Smith.

"A year ago we requested change in the weight of the re-entry system to 1050 pounds," answered Commander Julian. "The new 1023-pound weight actually represents a manipulation with the weight of the heat protection and the flare and so on. I do not think this weight is attributable to AEC changes.

"The heat shield weight is not firm," he continued. "The 38-pound figure will depend on our getting a strong enough diaphragm at that weight."

"Two pounds of the 19 extra pounds are caused by a heavier firing unit and the cabling associated with it," said Captain Dubyk.

"From information obtained from the pressure-loading on the A3X-7 and A3X-8 flights, the heat shields are 11 pounds heavier than predicted. There is a very definite indication that if there is to be any kind of predictable separation and/or post-second staging control,

## MISSILE COMMITTEE DISCUSSION

there has to be a fairly substantial structure there. We feel that we can effectively beef up the structure with the final weight only 11 pounds over the estimated 27 pounds. This change would take care of the heat effects which have been noticed in the central area of the diaphragm particularly, and also accommodate the pressure-loading problem."

"Is the post-staging the only environment of concern?" asked Captain Sanger.

"No," replied Captain Dubyk. "I feel that the original weights would be enough to take care of only the second staging, but to take care of the separation and post separation, there simply has to be a better blast-resistant structure."

"Has anyone considered diverting the second stage at the time of staging?" asked Captain Sanger.

"This is a feasible solution," Captain Dubyk said, "but it could not be accomplished until several seconds after the staging when the re-entry bodies go off, and the added protection would still be needed to protect the guidance package and permit this kind of maneuver. The added protection in the diaphragm is required at staging."

"It would not help in this situation," observed Admiral Smith, "because the maximum force is incurred when the separation rockets are ignited. The force comes from the jets of those rockets and the re-entry system and the second stage have to be together at the time the jet is created. This solution would not really help the problem."

"That maneuver, however, has been suggested as a useful one as a result of some findings on the Trinidad Radar tests," said Captain Dubyk. "Apparently, if the bodies remain together, there is some something that the radar can home in on and use to start discrimination. Getting it out of the way and out of the cloud would be a good use of this maneuver that Captain Sanger has suggested."

## MISSILE COMMITTEE DISCUSSION

"This is applicable only to A2," said Commander Julian. "The A2 is thrust terminated but normally the A3 second stage would be over flying unless it were being employed at extreme maximum range."

"Might it also be desirable to have this kind of maneuver in the A3?" asked Captain Dubyk.

"It might be, particularly if this stage could somehow be fragmented," commented Commander Julian. "This possibility will be investigated with tests on six rejected A3X chambers."

Continuing his report, Captain Dubyk said, "The PX portion of the re-entry system has increased 17 pounds over the weight estimated last June and is 13 pounds heavier than the December estimates. The weight changes are due to the fact that the earlier estimates were based on general designs and we now have detailed designs. Consequently, the latest estimates probably have a great deal more validity than the previous ones."

"What other areas are still undefined?" inquired Admiral Smith.

"The firing unit and the velocity sensor for the PX-2 are still loosely defined," answered Dr. Wilson.

"The weights I have quoted include the standard firing unit," added Captain Dubyk. "The use of a single case and having three in there reduced the weight by one pound at that point. The PY-2 is an addition since the June meeting and adds a straight 6 pounds to the total."

"What changes are still being considered?" asked Admiral Smith.

"The biggest change still being considered is the backup program that is going in parallel with the present two-pin EBW, and their present connectors," Captain Dubyk stated. "This area has the single largest potentiality for change and it is a substantial effort; we hope to introduce

## MISSILE COMMITTEE DISCUSSION

the so-called single-pin EBW firing units and detonators associated with their coaxial cable networks in the A3X-27 flight.

"It is my understanding that the progress to date on this equipment has been quite satisfactory. We still hope to have some testing prior to the A3X-27 and incorporate it on that flight. The units will represent very substantial improvements in assurance and makeup. They are better designed for a high voltage operation and provide the capability for voltage testing after makeup."

Admiral Smith introduced the question of how the units were tested and Captain Sanger explained that the design incorporates a tri-axial plug with the coaxial cable feeding into the center pin and the tube around the center pin. The bridge wire is connected between the center pin and the case and the electrical check is made between the tube around the center pin and the case, both of which are nominally grounded.

In response to further questioning from Admiral Smith, it was established that there was continuity in one side of the circuit and only one side of it could be checked.

"This change will mean that there will be all new squibs and detonators," Admiral Smith remarked.

Captain Dubyk answered that the change would make a radically new ignition system with completely different squibs, connectors, and detonators. He further pointed out that the change was being made without getting rid of the present system. The change will, he added, incur some weight penalty because of the coaxial connectors.

"Will this change cause modifications in the launcher?" Admiral Smith asked.

"It is our intention to manufacture all the 1200 gas generators now programmed with the existing two-pin unit," Dr. Mechlin said.

## MISSILE COMMITTEE DISCUSSION

"There will be a substantial delay between that and the next procurement which will allow additional experience to accumulate; a decision will be made around January 1964 about making a change. The new single-pin unit can be accommodated if the threads which connect it to the pyrotechnic device remain unchanged."

"The alternative is a redesign of the motor igniter," said Dr. Wilson. "The change should involve only the electrical system and should not change the mechanical interface at the output of the squib. The pyrotechnics in the squib itself will remain the same and there will be no change in the ignition train."

Admiral Smith then asked about the testing schedule for the new equipment and how long it would require to establish the standard of reliability obtained with the present equipment. In answer to these questions, Captain Dubyk said that the testing should be completed by November, but the time schedule would depend on when the new units were available.

"The first-line hardware will be available within two weeks," said Dr. Wilson, "and assuming that there are no significant design problems, the program does allow for sufficient testing before the flight commitment on the A3X-27."

"When will your level of assurance be equal to that existing in the present equipment?" asked Admiral Smith.

"To get a comparable number of firings it will take up to near the end of next year," replied Dr. Wilson. "To get to a point we feel is sufficient testing for commitment to production, however, will require only to the end of the summer."

## MISSILE COMMITTEE DISCUSSION

Admiral Smith then asked about the lead time required for tactical procurement and Dr. Wilson established that the order for the A3P would have to be submitted in August. He said that the date had been established in the recent Missile Working Group Committee meeting where it was agreed that instead of the usual time requirement, which would have necessitated orders in February, the deadline would be August.

"How are these things changed by agreement?" asked Admiral Smith.

"The earlier requirement was made with the understanding that the squibs would be assembled into the ABL motor adapters," Captain Dubyk answered. "In that kind of assembly sequence this would have to be done prior to loading of the motor and the items would be shipped from the adapter manufacturers with the squibs in place. We agreed that the squibs would be inserted at Bacchus. The prior sequence of assembly required supplying the EBW's to the igniter adapter people. The assembly was to be done by them and then the item shipped to Bacchus. With this assembly sequence, the parts would have to have been ordered one month ago. Since this is patently impossible, the assembly sequence has been changed and will be done at Bacchus which will give about three more months lead time."

"You will never get a pressure check on the seal on that joint in that sequence," observed Dr. Wetmore.

"That is what you pay for changing the sequence and hence the price for having the opportunity to change the design," Admiral Smith said.

"That is the worst situation and is only potentially what you would pay," Dr. Wilson observed. "They have not given up on developing a means for the pressure check."

## MISSILE COMMITTEE DISCUSSION

"I think it is fair to say that with all the pressure checks that have been run in this area, there has never been any trouble," Captain Dubyk observed. "The only thing we are giving up is the convenience of the pressure test in that it is the only practical way we know for testing it without having it in the motor at the igniter assembly level.

"Continuing my report, I would like to discuss the tactical heat shield; we had hoped to have the tactical heat shield on the A3X-18, but information from the A3X-7 and A3X-8 flights has given some concern for the blast pressure conditions and the need for better assurance of protection to the re-entry body and better PX stability on separation. In order to accommodate the A3X-18 flight, we have strengthened the structure as an interim measure and have slipped to A3X-27 for the fabrication of the tactical structure. There is no final design of this component but it appears that the over-all limit of 38 pounds will be feasible for production of the tactical model. It will have the same weight but will probably be a deeper beamed structure to give the stiffness required in the structure. The design, however, is not finished and remains one of the gray areas.

"There is still some discussion about the weight of the interim model but it probably will be about 44 pounds with the addition of a stainless steel plate. It will be a very rugged structure but will be six pounds over the weight estimate. These figures are based on the assumption that the structure should be able to see 65 psi. Originally 35 or 40 psi was the estimate but the A3X-7 and A3X-8 flights changed the figure to 60 psi."

A short discussion followed between Captain Dubyk and Admiral Smith about the status of the installation of brackets for putting ORRT warheads on tactical missiles in the tubes. It was established that the bracketry weighing about four pounds had been installed. Admiral Smith felt that there had been some misunderstanding about the authorization to install the equipment, but Captain Dubyk was under the impression that the Admiral had authorized the change at the conclusion of the last Missile Working Group meeting.



## MISSILE COMMITTEE DISCUSSION

"One of the biggest problems in getting the qualifications accomplished on the EBW system had been the vendors on the squibs and detonators," Captain Sanger commented. "I would say that their performance had been anything but outstanding and would like to know that precautions have been taken in the new design to make sure that there is enough hardware to carry out this tight qualification program."

"We are choosing better qualified suppliers for procurement of these parts," Captain Dobyk answered. "One of our earlier problems had been contracting with many small companies all over the map, each of whom produced a small piece. The new plan will cost more money but will provide a much more stable structure. For example, Eitel-McCullough has been selected as the leading producer and would not work except in terms of a \$75,000 order."

Captain Sanger asked if there was any assurance that this item would not become a controlling factor.

"No," Dr. Wilson answered. "I am not confident because we have not done the job yet. We do believe, however, that we are taking advantage of past experience and have as much confidence as possible under the circumstances. There are three vendors producing hardware now. We believe that the production problems with the item should be substantially less than with the original design but that remains to be proved. All the vendors are within one week of the initial schedules which has provided some confidence. However, the hardware is not sufficiently advanced in the production stage to be able to say with great assurance that the production will not be a problem to us."

Captain Dobyk agreed with Dr. Wilson and said that although the timescale made it a difficult problem, the past experiences and mistakes were being utilized as a background for the program. He said that Lockheed was tracking the production problems through the vendors so that difficulties would be spotted soon enough to enable corrections to be made. "It is not an easy program," he stated, "and I do not have a 90 per cent level of confidence that the item will be available by the

## MISSILE COMMITTEE DISCUSSION

A3X-27 flight but somebody has to have faith; Lockheed may, but certainly somebody must.

"There is a great deal of testing to be done before that flight with about 2000 EBW's remaining to be tested. There are problems we cannot anticipate, on sealing for example, but benefiting from the past mistakes with the advantages of the obviously simplified design will serve us in good stead this time."

Admiral Smith asked Dr. Wilson if there was any assurance that the pyrotechnics would not be changed in the new units.

"We have reasonable engineering confidence," answered Dr. Wilson. "By moving the bridge wire from the center pin to the case, we have, with hand-machined units, loaded approximately 100 units and have run a Bruceton-type distribution test in which no change in the mean or spread of data on energy requirements for initiation and distribution was obtained from the two-pin type EBW. This work was the basis for my saying that there is no significant change that we can detect at this point in the pyrotechnics of the two units."

"It still remains to be seen that this will be verified after production but from what we have been able to do until the production items are received, we feel that there should not be a significant change."

"What is the nature of the seal that is not being checked?" asked Admiral Smith, and Dr. Wetmore explained that it is an O-ring seal between the adapter and the squib itself. "It is not being tested with the new units because the igniter is sealed and it is not possible to get the pressure to the ring without breaking the seal or bypassing it somehow." He suggested that the testing be waived on the initial units and put off until a supply was accumulated. "Being able to pressure-check the unit will compromise the igniter from the hermetically sealed design which protects it from the atmosphere. If it has to be done from a supply standpoint, it should be done this way."

## MISSILE COMMITTEE DISCUSSION

"There has been no leakage seen in any of the pressure testing done to date on these assemblies but it is possible that a test could be devised and perhaps put in the material to test the seal. This area is getting further study.

"The working group felt as a group that as of our experience to date, there has been fairly experienced testing and this is not a joint that should give any trouble. There always is a possibility, however, that the O-ring could be left out and probably from a long range point of view testing will be recommended as soon as the situation permits. This might require several months of tactical production before testing could be re-instituted. About 70 to 100 units will have been produced by then."

"What weaknesses of the two-pin design are being corrected by the new one?" Admiral Smith inquired.

"The first advantage," explained Captain Dubyk, "is a substantial improvement in the assembly assurance. These are delicate pins and some of the accesses for making up the EBW's were very difficult. These problems have developed under carefully controlled conditions and we worried about the problem when there are general conditions without the carefully controlled supervision we have at the Cape.

"Another advantage of the new design is increased reliability. The two-pin design was not really basically designed for high voltage use. From the point of view of high reliability and proper operability, the coaxial connector is a better functioning item.

"Use of the single-pin will also eliminate a very difficult assembly process. There has been difficulty in consistently fabricating and properly sealing the two-pin EBW. Assembly is a very tricky process involving the proper sealing of the pins themselves with an enamel-like material around the base.

## MISSILE COMMITTEE DISCUSSION

"I do not think that we can stress too much that the past designs were inherently fragile. They could be improperly assembled and there was no way of making sure that they were properly assembled except by having two men watching the ordnance man assembling them, and then by X-ray testing.

"Another production factor that would make the design unsuitable for tactical production is the cleaning process required before the silicone grease is put in around a disc in the unit. The cleaning is necessary to prevent high voltage leakage paths and the silicone grease is sort of a magnet to dirt. This is the kind of situation where in tactical use, the requirement for all this cleaning would not be suitable for material that would have to be handled aboard the submarine or at NWA."

Admiral Smith questioned Captain DUBYK about the addition of re-entry vehicle stabilizers and it was brought out in subsequent discussion that the development was still in preliminary design and appeared to require a complex mechanism.

"Two shots, the results of which are shown in figure 4, have been fired since the last meeting. In both, the A3X-9 and A3X-11, the first staging was quite satisfactory but in the A3X-9 flight there was a blockage of one-half of the Freon manifold.

"Figure 5 is a schematic of the Mod 1 TVC system. It consists of a gas generator with a hot gas relief valve underneath it. About three seconds before staging at about 0.95 g in the deceleration phase, the gas generator is activated. At generator ignition, there is flow of gas into the toroids; if the gas pressure is too high, it is dumped overboard through the hot gas valve. On the Mod 1 the two halves of the toroid are pressurized and the gas pressure acts on the outside of a rubber bladder, squeezing the Freon through a flow meter into a manifold and then out the individual assemblies for each nozzle.

## MISSILE COMMITTEE DISCUSSION

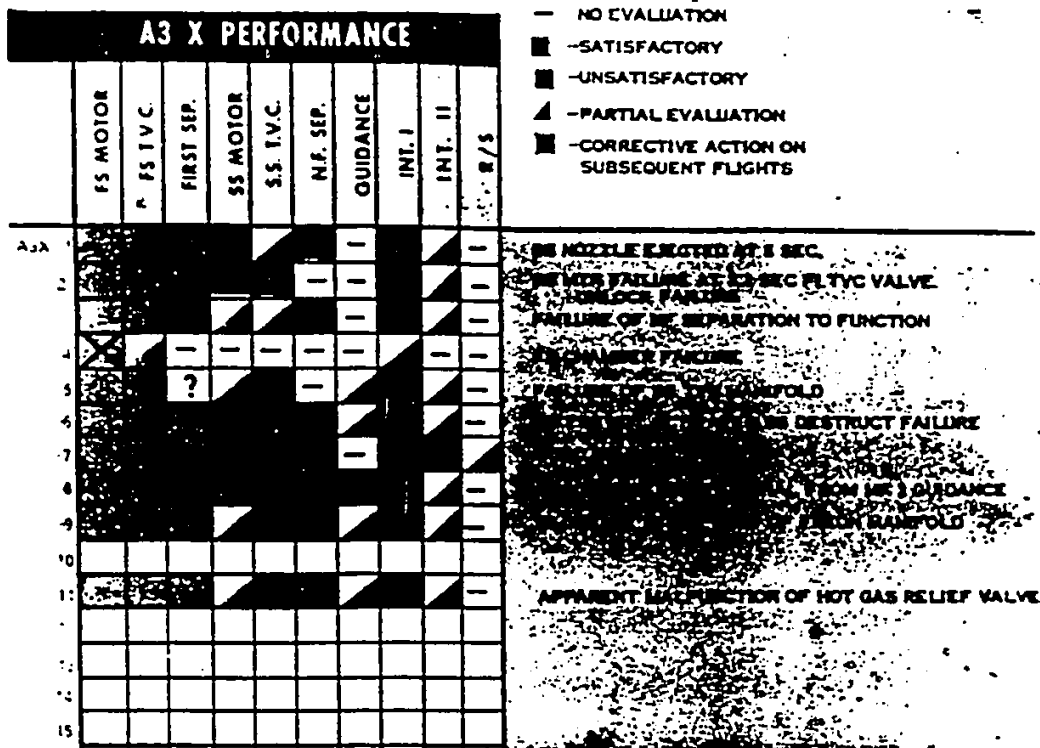
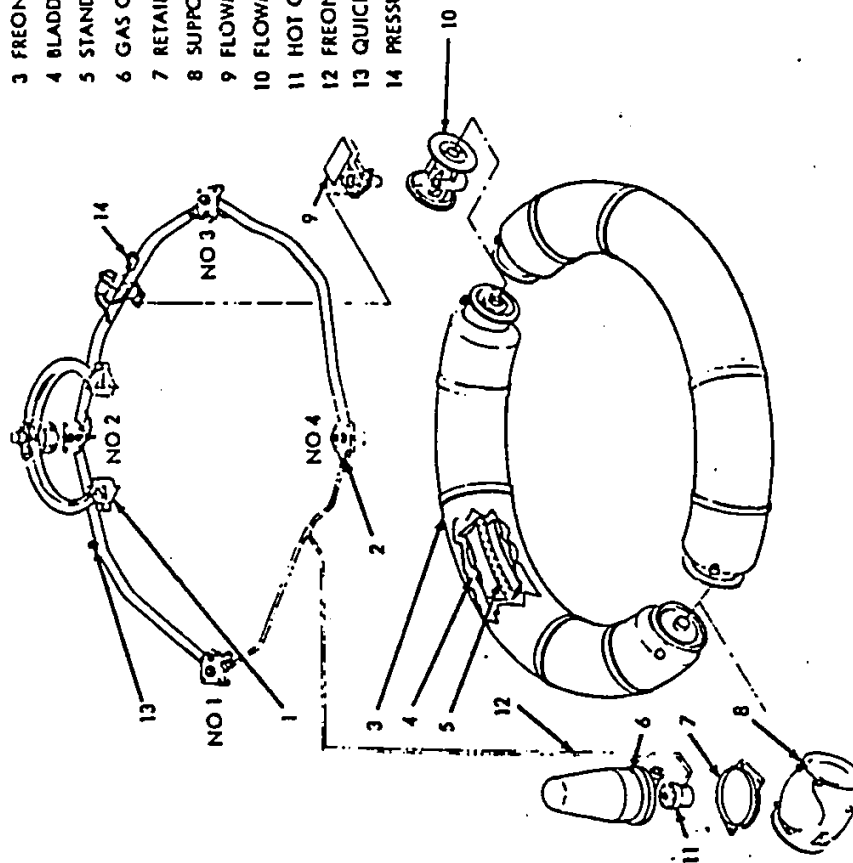

Figure 4

"In the A3X-9 the gas generator operated very nicely and the flow meter pressures were good, but somewhere downstream from the flow meter, the system had a blockage of some kind. It has been postulated that blockage in the manifold caused the failure in the system on the A3X-9 flight. The manifolds were shipped with a plug in them and we have postulated that this unit was assembled with the shipping plug retained, very much like a cork. Needless to say, that particular shipping technique, using that kind of protective plug, has now been eliminated."

- 1 INJECTOR VALVE ASSY-4 REQ'D
- 2 MANIFOLD-WIRING ASSY
- 3 FREON TANK ASSY
- 4 BLADDER
- 5 STAND PIPE
- 6 GAS GENERATOR
- 7 RETAINER
- 8 SUPPORT
- 9 FLOWMETER
- 10 FLOWMETER HOUSING
- 11 HOT GAS RELIEF VALVE
- 12 FREON PRESSURE SENSING LINE
- 13 QUICK DISCONNECT
- 14 PRESSURE TRANSDUCER



FLUID INJECTION SYSTEM

Figure 5

## MISSILE COMMITTEE DISCUSSION

Admiral Smith asked a series of questions relating to the shipping procedure for these units and members of the group explained that ordinarily the units are assembled and the manifold is shipped as an entire unit to AMR. For the A3X-9, a replacement manifold was shipped separately because there was some concern about an electrical connector that might cause problems in flight. For that missile a spare manifold was shipped with a plug in it to AMR. When the pressure of the gas generator exerted force, the plug may have been blown in and down the manifold.

Admiral Smith questioned whether a shipping plug could actually have caused the failure and Dr. Wilson answered, "In test, a deliberate restriction was put into the unit and we were able to simulate the performance of the missile almost precisely. We were unable to prove that any specific mechanism caused the failure; all that can be said is that there was a bad practice here in that a possibility of improper assembly existed which could have caused this failure or some other."

"The result is that we now are certainly testing for clear bore," said Captain Dubyk.

"Regarding the failure in the thrust vector control activation on the A3X-11, the pressure pattern indicated that the failure probably was due to either a hole up stream from the flow meter or a stuck valve. During the flight, the pressure rose to 770 psi and kept going to 890 psi. Normally, at pressures of  $750 \pm 25$  psi, the hot gas valve is supposed to dump overboard. At about six seconds when the pressure was at 890 psi, it started going down exponentially. Ten seconds after activation the pressure was at 450 psi, the lower limit of satisfactory operation, and at 13 seconds, the time that telemetry was lost, pressure was at 150 psi.

"From the data it is quite certain that the hot gas valve did not open as quickly as it should and from that it can be postulated that it did not close as it should and continued to dump gas. It is also possible that there was a hole somewhere in the line.

## MISSILE COMMITTEE DISCUSSION

"As a result of this failure, all the factory records and the valve heads are being rechecked. All these valves are tested at the supplier, Thompson Ramo Woolridge who runs seated and unseated pressure tests; retesting is done at Atlantic Research where the unit is assembled before shipping to Lockheed. All the test records are being checked to determine what variations we have.

"In addition, there will be a disassembly operation on seven extra systems. These systems will be checked as a backup to the check of the A3X-14 system to determine if there is a time-dependent factor in performance of these valves. The corrosion or permanent setting of O-rings will be looked for. The tolerances will also be checked. It may be that a worst-on-worst situation will cause improper valve function.

"We hope to have significant information on the problem by next Tuesday. At that time we hope to be able to suggest what caused the A3X-11 failure. On that basis, either we will go ahead with the A3X-12 firing or suggest postponement of that flight.

"People will be brought in who have had hot gas experience on the MINUTEMAN and TERRIER programs in the hope that they will be able to suggest possible modes of failure from their experiences.

"In addition to all of these corrective measures, two entire Mod 1 systems will be put together. One of these units will be run at Santa Cruz to check its operation. If that test is satisfactory, the other will be run on a centrifuge to check the performance under those conditions.

"The Mod 2, shown in figure 6, is a very important step forward in the thrust vector control system. It is scheduled for installation in the A3X-18 and since practically all the components are different, will be one of the really big changes in the system. The new manifold configuration in this system will save 178 pounds and add 104 miles in range."



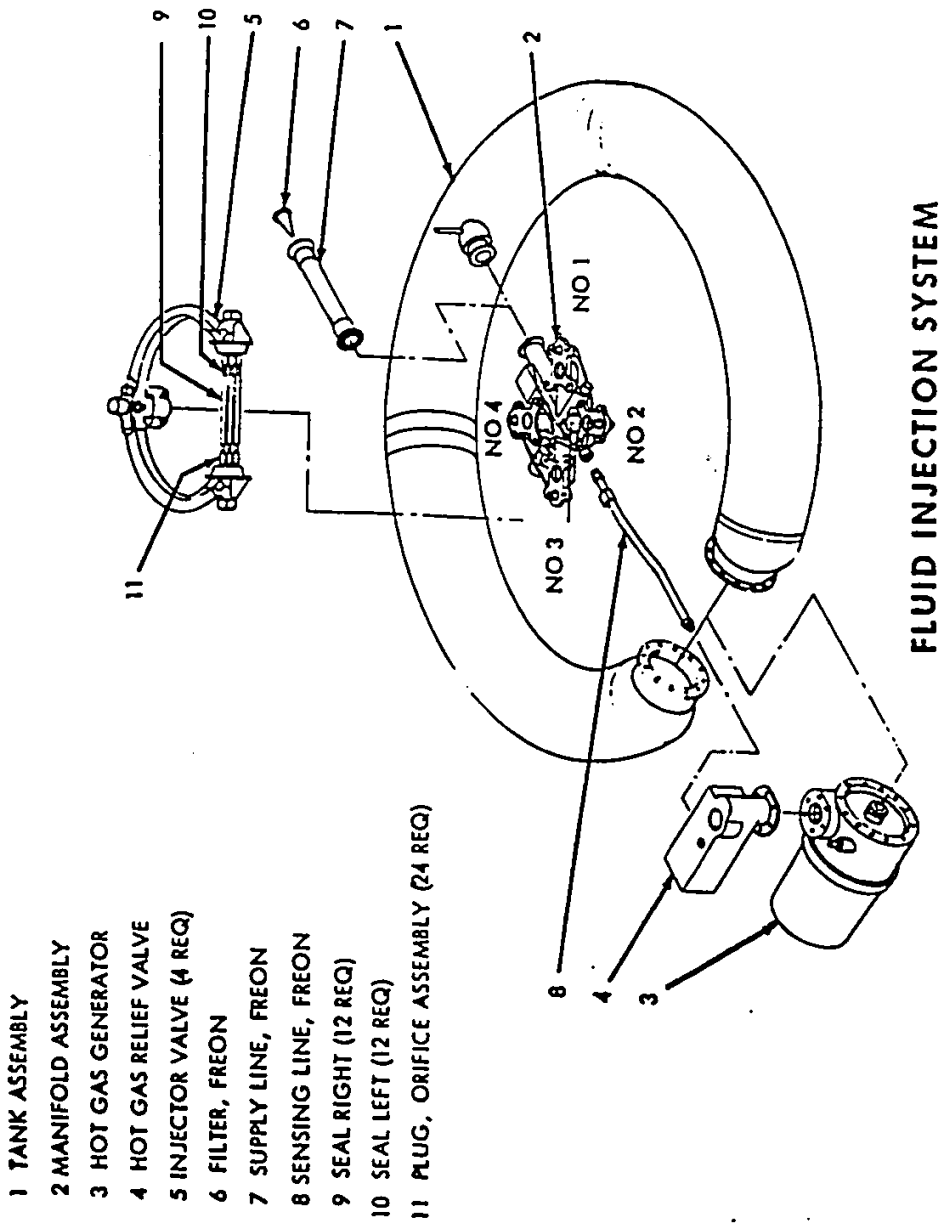

Figure 6

MISSILE COMMITTEE DISCUSSION

Answering a question from Captain Thompson about the difference in the functional components of the Mod 1 and Mod 2, Captain Dubyk said, "The main reason was the weight saving advantage. One of the big reasons for going from the Mod 1 to the Mod 2 was the fact that a good deal more Freon than was necessary was provided in the Mod 1. Recognizing that it was going to be very hard to meet the 2500-mile range, we made the decision to effect this change. When the Freon flow changed, requirements were changed very substantially; everything all along the line had to be changed.

"It is true that starting with the A3X-18, we will begin again with the thrust vector control problems, but this Group grudgingly recognized last June that we needed the change for range improvement.

"Figure 7 depicts the A3X flight test schedule."

### A3X FLT TEST VEHICLE STATUS

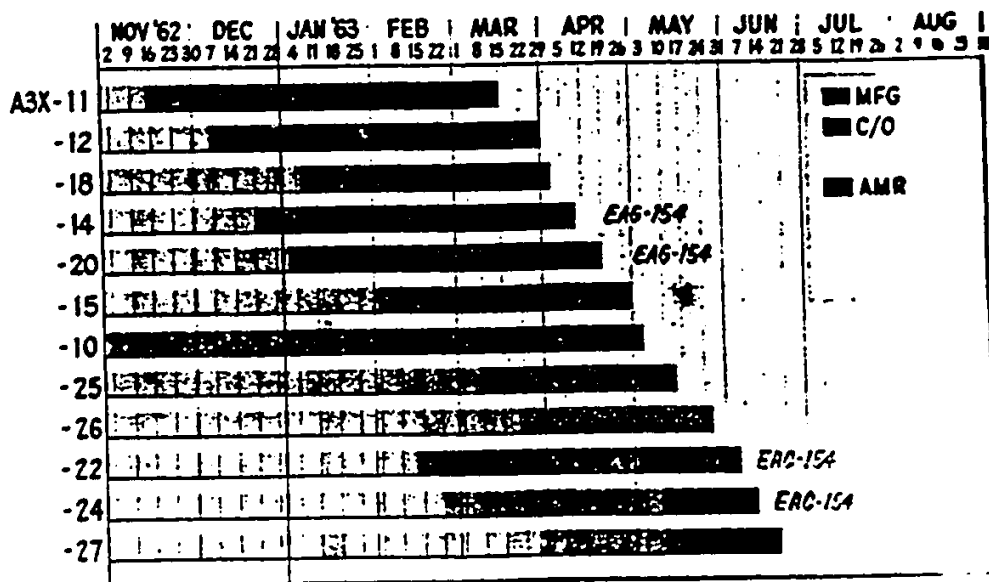

Figure 7

MISSILE COMMITTEE DISCUSSION

"On how many flight and static tests has the Mod 1 performed satisfactorily?" asked Captain Sanger.

"The Mod 1 has only seen flight tests on the A3X-7 and A3X-8," Captain Dubyk answered. "They have been tested on other A3 missiles, but the flights were aborted for some reason and the Mod 1 did not get to perform over its entire range. It has seen four successful ground tests of the entire system at Santa Cruz and there have been three of the so-called flight confidence tests which were successes; that makes a total of seven successful tests. There has been one partial success and one that was labelled an out-and-out failure. The failure was a unit that had been used previously and probably was not cleaned properly for reuse. From our past experience this component has been one of the more reliable.

"On Tuesday a decision will be made about whether to go back to the shop or to go to the pad with the A3X-12. If there is some cause for concern or if some further testing appears warranted, we will recommend postponement of the flight test. If there is no basis for concern or if no intelligence has been discovered by that time, we probably will recommend flight testing."

Dr. Craven suggested that solids generated in the gas generation process could have caused the blockage but Captain Dubyk felt that the suggestion did not have validity as a failure mode because the valve is seated at a temperature of about 1100 degrees and it is quite likely that a solid would burn at that temperature. Post-firing examination of a diaphragm which pops when the system gets up to pressure also disproves the theory. The diaphragm breaks in such a way that it is scored around 320 degrees but the portion that stays hinged has never shown any signs or scoring or erosion.

"We are stuck at the moment," Captain Dubyk said. "There are better candidates for failure than this one."

There were no further questions from the STG members and Admiral Smith recessed the meeting for coffee.

RE-ENTRY BODY COMMITTEE  
REPORT DISCUSSION

"The first item on my agenda," said Commander Julian, "is the status of the Y2 warhead which is an improved-yield version of the Mark 47 warhead to be carried on both A1 and A2 missiles. As the AEC promised, the first production unit was completed in February. Four units have now been produced. Three have been delivered and are at NWA Charleston, while the fourth is in the new materials test program at Medina. Present status of this program is shown in figure 1.

"All of the product change proposals were completed, two of which were particularly important: first, a change in the pit material to a different allotrope of plutonium which will decrease the neutron vulnerability of the warhead; second, the relocation of the boosting gas reservoir to a point outside the warhead seal which will simplify future problems of bottle exchange.

"Until February, there was some doubt as to whether the AEC would be in a position to certify a four-year stockpile life for this new system. On the basis of previous partially successful nuclear tests, they could not specify what the fill for the reservoir should be with the new pit. The doubts have now been resolved by a successful test called CASSELMAN; the system is certifiable for the normal four-year stockpile period. The formal requirement now exists for the AEC to deliver 67 of these new warheads to the DOD by the end of this fiscal year. They evidently will have no difficulty in meeting this peg point number, but we have asked them to let us know officially if they foresee any difficulty. We have already informally talked with the Fleet people, and it appears that we could accept the lower number without perturbation to deployment requirements.

"The system is probably intended to be first deployed on SSB(N) 618. There is another possible problem area, for we understand that CINCLANT intends to place this new high-yield warhead in all

RE-ENTRY BODY COMMITTEE DISCUSSION

A1-A2 boats in the ratio of 50 per cent Y2's and 50 per cent Y1's. We hope to get some firm guidance on this point by the end of next month."

In response to a question from Admiral Smith, Commander Julian explained that the fifty percent figure is based on release of the Y1 warheads from the 598-Class at overhaul, as then there would be about 151 or 152 of each of the model warheads and the fifty-fifty division would seem quite natural.

MK 47 Y2 WARHEAD STATUS

1. FEB 1963. FPU MET  
4 UNITS ( 1-NMST, 3 IN NAVY CUSTODY)  
PCP CHANGES INCORPORATED
2. FEB 1963 - SUCCESSFUL TEST DELTA PIT  
PERMITS RESERVOIR FILL SPECIFICATION  
4 YEAR STOCKPILE LIFE CERTIFIABLE  
OFFICIAL YIELD 1.1 MT.
3. 1 JULY 1963 - EXPECT 67 Y2'S ON HAND  
NO DIFFICULTY IN MEETING REQUIREMENTS  
OFFICIALLY KNOWN
4. 30 AUG 1963 - SSB(N) 618 DEPLOY
5. DEPLOYMENT LOAD - OUT PLANS NEED FIRM  
DEFINITIZATION

Figure 1

## RE-ENTRY BODY COMMITTEE DISCUSSION

"Figure 2 covers in some detail the results of the re-entry system participation in the A3X flight program," continued Commander Julian. "The IH refers to inert heads which carry no instruments, only SOFAR bombs. The DH heads carry 5 kmc. tracking body instrumentation and the NOL-AFD portion of the FAF system, but will not carry any warhead electronics. The DW head, that shows up with the A3X-7, is a warhead prototype test body which includes both the NOL and AEC portions of the firing system. On the A3X-7, A3X-8 and A3X-9 we had environmental rather than functional flight-test units, but the fourth one, A3X-11, was a functional unit.

"We have expended over 20 of the inert heads, quite a few of the DH heads, and 4 of the DW units, including all of the flight test environmental units. From all this, we have obtained about ten seconds of flight data from the A3X-7.

"Our situation is not good, particularly because of the large uncertainty in our knowledge of where the bodies on A3X-7 impacted. We are still in need of some idea of what the actual impact pattern is. As of the day before yesterday, it appeared as though the re-entry impacts were essentially in a line. The bearing on the line of bodies was about 30 to 40 degrees off the trajectory axis.

"Early this morning we had a new reading, purportedly more correct, indicating a large 2-sigma tolerance ellipse around at least one of the bodies. If we can believe this, then we can roughly fit in our desired impact triangle."

"Did I understand you to say that you only had ten seconds of data for the re-entry environment?" asked Admiral Smith.

"We have no data for the re-entry environment," replied Commander Julian, "because the DW body had difficulty in telemetry and only provided data for ten seconds prior to actual re-entry. From this, we saw what is essentially a free-flight environment, the temperature, vibration, spin, and so on.

---

RE-ENTRY BODY COMMITTEE DISCUSSION

<u>RE-ENTRY SYSTEM PARTICIPATION</u>				
<u>A3X FLIGHTS</u>				
	<u>HEADS</u>			<u>DATA</u>
	<u>A</u>	<u>B</u>	<u>C</u>	
A3X-1	IH	IH	IH	SELF DESTRUCT
A3X-2	IH	IH	IH	DESTRUCT
A3X-3	IH	IH	IH	DESTRUCT
A3X-4	IH	DH	IH	SELF DESTRUCT
A3X-5	IH	DH	IH	DESTRUCT
A3X-6	IH	DH	IH	SELF DESTRUCT
A3X-7	IH	DW	IH	3 BODY IMPACT
A3X-8	IH	DW	IH	2 BODY IMPACT
A3X-9	IH	DW	DH	DESTRUCT
A3X-11	IH	DH	DW	DESTRUCT

Figure 2

## RE-ENTRY BODY COMMITTEE DISCUSSION

"We also have no re-entry environment data from DH or DW flights at this time, but as yet, I am not too concerned. I think our design is sufficiently conservative, particularly in the structure, that it will survive the re-entry heating environment. What bothers me most is the fact that this FAF is a single-channel system, as opposed to the redundant two-channel system that we have in the Mark 1. It must be highly reliable; thus the more flight data we get on its performance, the better we can identify and fix any difficulties we see. In this sense, our situation is not good.

"The next shot, A3X-12, will be the first Code 3 and will carry three instrumented DH bodies. We certainly hope that this is a successful firing."

"We had a telemetry failure on A3X-7, but did we get impact information on A3X-8?" asked Captain Sanger.

"A3X-8 was a missile failure," answered Commander Julian.

"The two-body impact means that we saw two SOFAR signals, but there was a very tight pattern right around second stage, indicating that they did not get properly separated.

"Figure 3 is our planned participation in the next five A3X flights. You will see some new nomenclature: AH is the new Azusa tracking body, and IH is the Lockheed-instrumented body containing 240 megacycles of telemetry. The DW and IH will be the same. A3X-12 is the first Code 3 with three instrumented bodies. A3X-20 is another.

"During the PX-1 flight test program in PMR we had difficulty establishing the performance of our chaff packages properly. We saw motion-picture film showing at least two clumps but not the third. The volume subtended by the two clumps we saw was not adequate to cover the center part of the tube. In particular, we think we have been looking between the two clumps and seeing the second stage and the re-entry body.



RE-ENTRY BODY COMMITTEE DISCUSSION

<u>RE-ENTRY SYSTEM PARTICIPATION PLANNED</u>				
	<u>HEADS</u>			
	<u>A</u>	<u>B</u>	<u>C</u>	<u>REMARKS</u>
A3X-12	DH	DH	DH	1ST CODE 3
A3X-18	AH	XH	DW	1ST MOD 2 TVC
A3X-14	DH	IH	IH	FIRST EAG
A3X-20	DH	DH	DH	EAG
A3X-15	IH	DH	DW	AMR

Figure 3

"The two packages supposed to cover this particular region were designed by Leesoona Moos Laboratories. We have checked the design of these packages and are satisfied that the vapor pressure of the silicone liquid was not properly selected for the actual flight environment temperatures. It was too sensitive to the temperatures, for one thing, so that the vapor pressure resulting when the lid came off the package was not sufficient to disperse the wires far enough. Another problem was possibly in the can itself coming off too slowly, so that some of the pressure leaked out. By the time the can came fully off, permitting the wires to actually move, we had less vapor than we needed.

"We are in the process now, after some extensive ground testing, of flight testing a new vapor technique which uses a heptane-pentane mixture. For the time being, we are going to flight-test packages that contain some 6-mil wire mixtures, but not 6- and 12-mil wire mixtures. We have changed some of the cover materials to Teflon. We hope that with these changes, including increasing the mounting rigidity of the primer in the Nortronics package, that we can demonstrate that the three chaff packages will cover the tube with the three envelopes of chaff.

## RE-ENTRY BODY COMMITTEE DISCUSSION

"To demonstrate this in flight, we have gone to the White Sands Missile Range with a small rocket called SPEEDBALL. They are buying eight of these at a cost of \$6500 each. The launch program and the safety studies are being conducted for Lockheed by the Physical Sciences Laboratory of New Mexico State University. The SPEEDBALL, shown in figure 4, is launched as a sounding rocket, almost vertically from a fixed launcher, and the package that is carried is a two-stage solid rocket with an apogee of over one million feet.

"Figure 5 shows the configuration of the payload section which carries several range appurtenances. The de-spin mechanism stops a spin of around ten revolutions per second by a technique that is essentially cancellation just prior to ejection of the working package. The figure also shows the Leesoona Moos package which is ejected on the way up, around 400,000 feet, as shown in figure 6. We will have the opportunity to observe the dispersion of the chaff both on the way up and on the way down.

"The first shot of this rocket for our program was conducted last week and was unsuccessful because the nose fairing did not separate. For some reason the rocket overflowed its predicted impact point by about 50 miles which caused some concern in terms of range safety.

"We chose eight rockets on the basis of three for the Leesoona Moos packages, three for the Nortronics, and two for a temperature survey. The selection was based on the availability of rockets; some of the SPEEDBALL's were already in existence at the range and the organizations that owned them said we could, because of our commitment to a program like this, use theirs with a promise of paying them back. We were able to procure six rockets under these terms.

"The design changes needed are not very significant at present and I hope they remain so.

SPEEDBALL PROFILE AND PARAMETERS

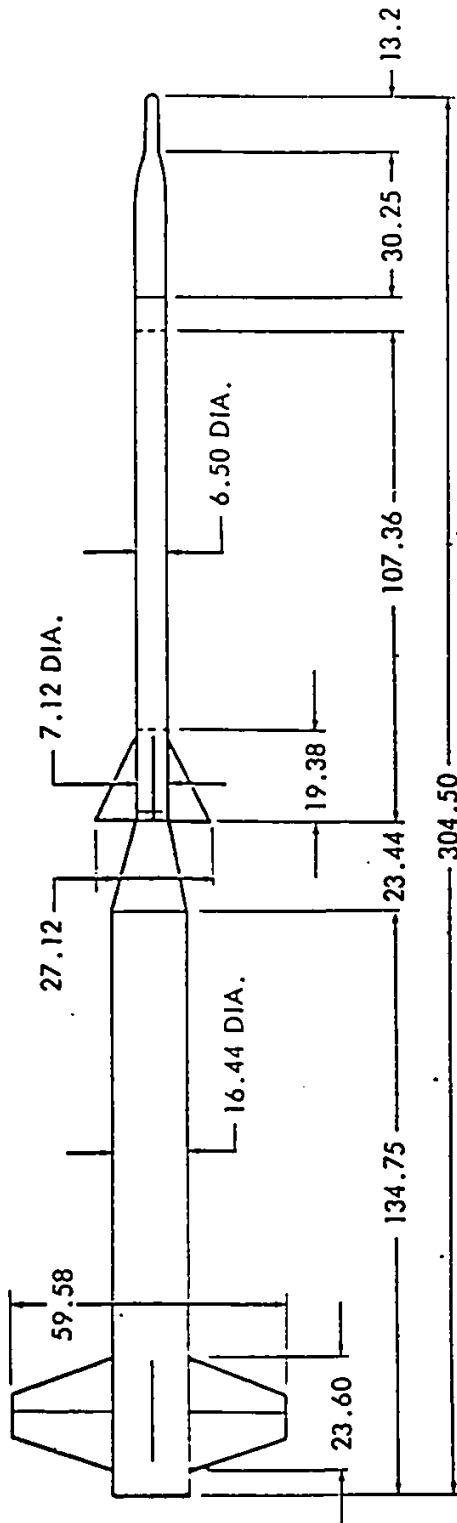

Figure 4

RE-ENTRY BODY COMMITTEE DISCUSSION

SPEEDBALL PAYLOAD

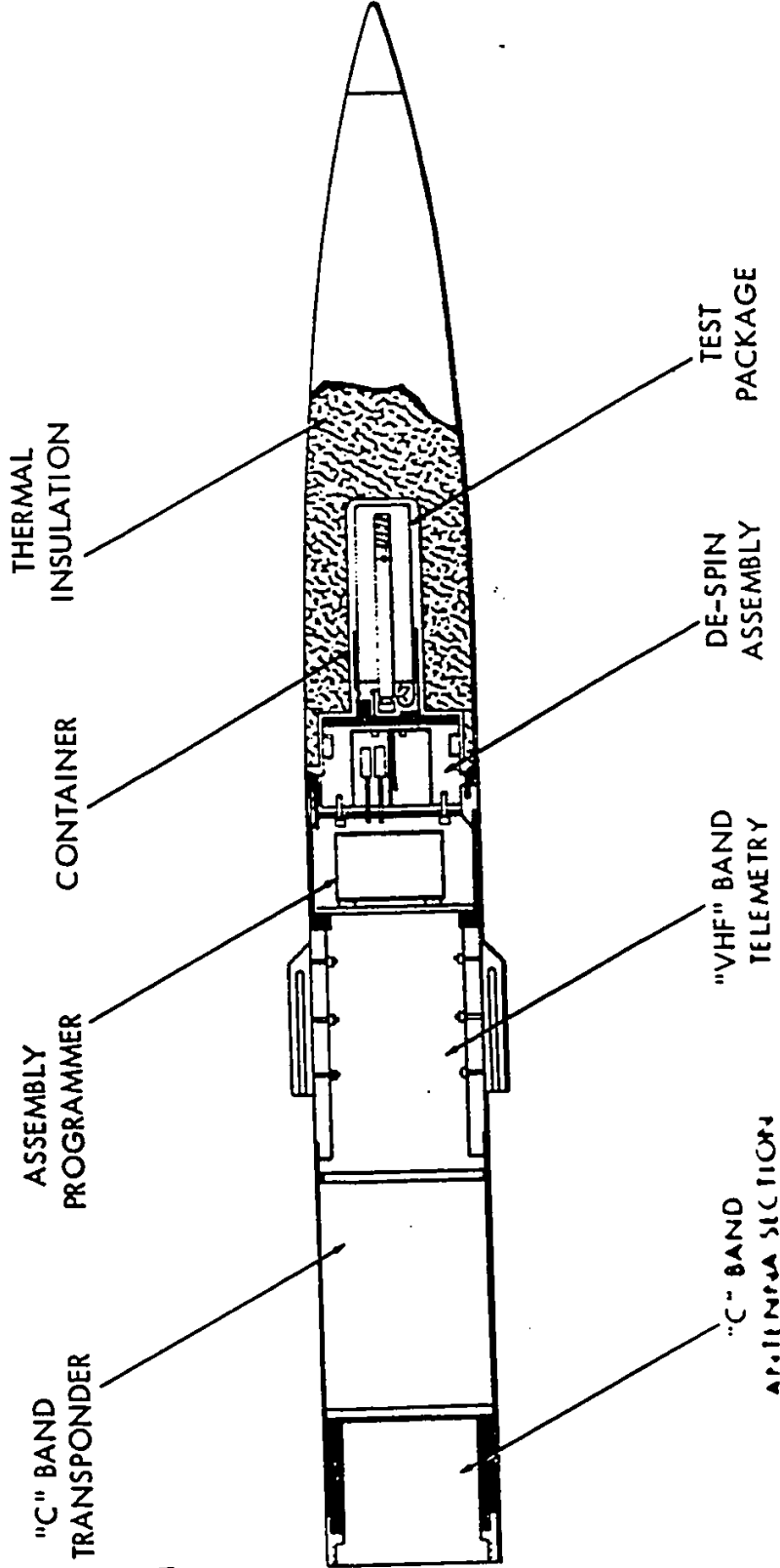

Figure 5

## RE-ENTRY BODY COMMITTEE DISCUSSION

"Figure 7 is the representation of that part of the White Sands Missile Range where our firings will be conducted. The impact dispersion is quite large -- over 20 miles cross range. We have C-band, S-band, and the whole NIKE-ZEUS radar complex, including the discrimination radar, looking at these packages. The NIKE-ZEUS discrimination radar (DR) and other ZEUS radars will be operating on the range until late May or so, and then will be temporarily deactivated for modification. At that time the discrimination radar is going to be shipped out to Kwajalein.

"The first firing was supposed to have gone 50 miles; it went a hundred according to the explanations given to me. I do not know what the impact point was, but the package was located by air search. They were trekking in to recover it the last I heard. The shot has been rescheduled and I presume the safety people were satisfied.

"One of the areas in which we and the other services are concerned is the blast vulnerability of re-entry systems, as defined in figure 8. Many questions exist in this area. If you accept the rather scanty theoretical work that is available and the even more scanty experimental data and plot the vulnerability radii from this data against the different kinds of nuclear defense phenomena, it usually turns out that the blast vulnerability radii far exceed the others. Part of the reason is the lack of precision in our calculations. We have very large uncertainties in both the blast effects and the response of the body to a given effect.

"Because of that concern, there has recently been an even more marked interest in blast vulnerability tests of both nuclear and non-nuclear types. In figure 8 I have listed a few that we are either being directly or peripherally involved in, and basically for a Mark 2 blast response.

"In one test to occur somewhere in the vicinity of Yuma, a large HE charge is going to be detonated. The project is sponsored by DASA for the Army, but they have invited our participation. We hope to get some scale models into the test with very minimal instrumentation.

RE-ENTRY BODY COMMITTEE DISCUSSION

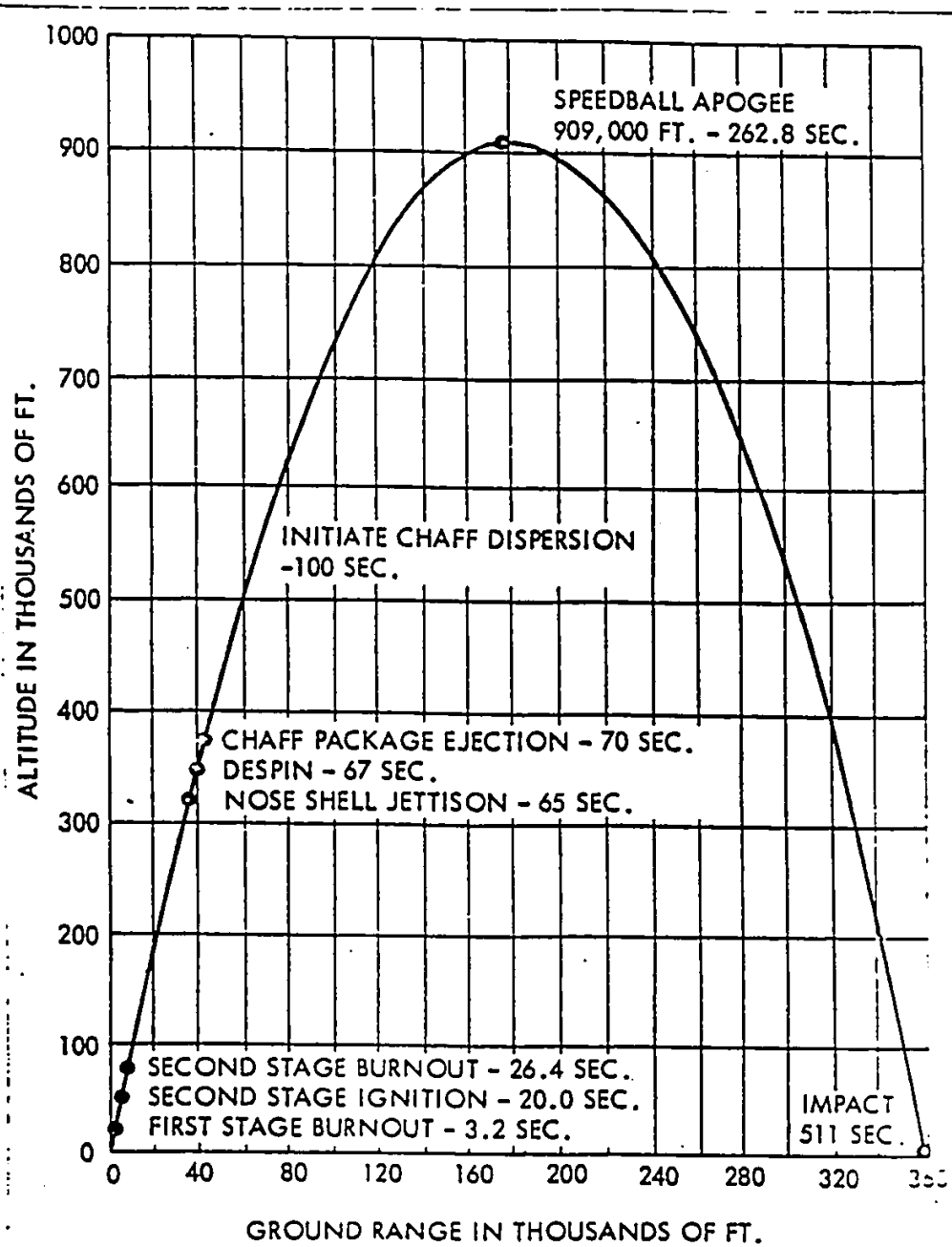

Figure 6

RE-ENTRY BODY COMMITTEE DISCUSSION

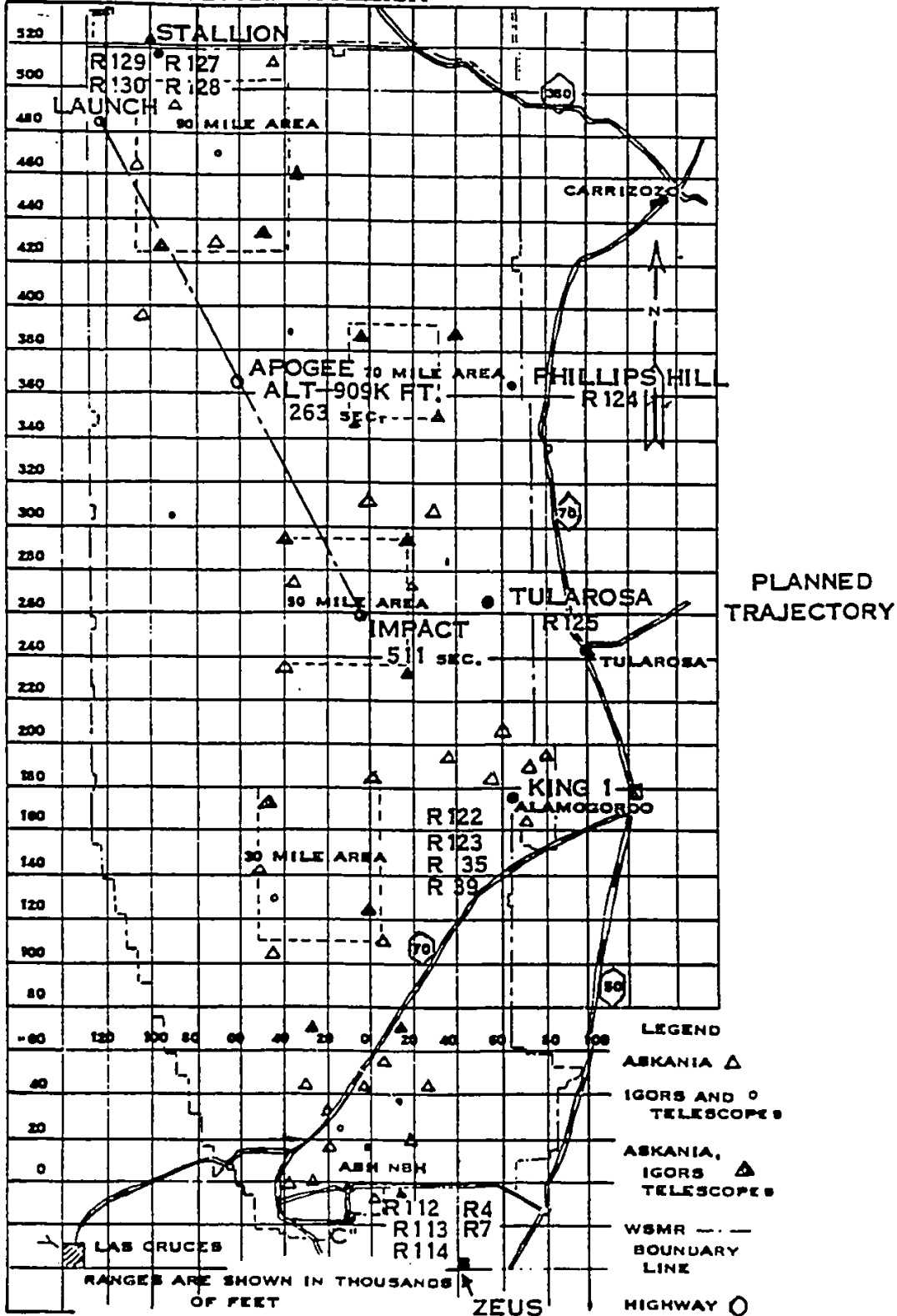

Figure 7

## RE-ENTRY BODY COMMITTEE DISCUSSION

We have proposed to DASA, for their funding -- and I do not think they will totally fund it -- another kind of HE simulation test in which we would mount full-scale Mark 2 instrumented bodies on a sled to be run at NOTS. The total project cost would be two or three million dollars. It turns out that our re-entry body is about the only one in the arsenal that you can conceive of accelerating up to Mach 3 on this kind of sled. We plan, if this program is approved, to fly these bodies off the sled after some tests in which we retain them captive to the sled.

<u>BLAST VULNERABILITY PROGRAM</u> <u>PROPOSALS</u>			
<u>TEST</u>	<u>SPONSOR</u>	<u>TYPE</u>	<u>REMARKS</u>
YUMA	DASA/ARMY/SP	HE	SCALE MODEL MACH 3 NO BODY RESPONSE
SLED TEST	DASA/SP	HE	FULL SCALE MACH 3 BODY RESPONSE
BLUE ROCK	DASA/SP	NUCLEAR	FULL SCALE MACH 10
SLEIGH RIDE	DDRE/USAF	NUCLEAR	FULL SCALE 3,000 MILES

Figure 8



## RE-ENTRY BODY COMMITTEE DISCUSSION

"While this Mach 3 will occur at sea level, these conditions are not too unlike the actual blast environment and shock wave conditions for the rather low altitudes which are most critical to blast vulnerability. We intend to put an HE charge off to one side; and then, by appropriate timing, detonate when the body reaches full velocity, intercepting the body with the HE shock wave. We will measure body response, loads, and pressure fields. This test is much better, from our point of view, than others of this kind that have been proposed because we can recover the body after the test.

"Two further full-scale nuclear tests have been proposed -- one called BLUE ROCK, which involves two nuclear detonations of around 200 kilotons each in the vicinity of Johnston Island. This test is proposed somewhat politically as the DASA answer to the Air Force-proposed SLEIGH RIDE test. I think it has some credibility as a test to provide generalized data for the use of all kinds of re-entry system designs. The plan here is to use THOR vehicles fired from one of the two pads now in place at Johnston. The THOR's would carry four pods that in effect would be instrumented re-entry vehicles. The THOR would be launched almost vertically, and the pods would be ejected after apogee with the appropriate velocity. A second rocket, NIKE-HERCULES, with the nuclear warhead aboard, will then be programmed for launch from Johnston Island to intercept the pod bodies at the desired altitude and at the desired vector distance between them.

"At our suggestion, Lockheed has made a proposal to DASA to look into the blast vulnerability of all kinds of re-entry bodies. With only a little additional dressing up, Lockheed and DASA can conduct the negotiations almost independently of us. They have asked us, and we have agreed, to act as technical monitor if the project is funded; of course, we do have some special interests in the project.

"The last change proposed by the DASA people was to use two re-entry bodies of the Mark 2 type and two of a more advanced sphere-cone design on the THOR. Now, if we can go with bodies that look like Mark 2, we can indeed get data which is germane to our own design."

## RE-ENTRY BODY COMMITTEE DISCUSSION

On questions from Admiral Smith, Commander Julian explained that the test program would be directed at determining blast vulnerability of representative re-entry systems, that four systems could be sent up in one flight by special pod attachments to a THOR vehicle, and that the re-entering bodies could then be attacked by a NIKE-HERCULES type of interceptor. Commander Julian added that some modification would be required on both the THOR and the interceptor.

"Basically, it is a DASA project," continued Commander Julian, "but they would presumably use a Lockheed-designated project officer. They wish us to be in the loop somewhere because we generated the proposal initially. I want to be in the loop because two of the bodies proposed for the test are specifically Mark 2-type bodies."

Admiral Smith observed that BLUE ROCK, in attempting to examine vulnerabilities of re-entry bodies at Mach 10 at 60,000 feet, should be a very interesting experiment.

"It will be interesting," replied Commander Julian, "but there is also another experiment underway called SLEIGH RIDE, for which BLUE ROCK is the rebuttal. This is a full-scale nuclear test to be launched on an ATLAS missile from Vandenberg using the Mark 11 MINUTEMAN re-entry vehicle.

"The intercept was originally to be performed by carrying the nuclear warhead on the same vehicle that carried the instrumentation. It would have a Broad Ocean Area impact in the Pacific some place. Originally, the experiment provided no means of getting diagnostic data on the detonation or any means, except recovery of the bodies themselves, to determine the effects of the blast interaction. It was very narrowly oriented to the vulnerability of a very specific re-entry vehicle -- the Mark 11. Since the original plan met with some objections from DDR&E, the program has been reoriented so that it will not be Broad Ocean Area impact but about a 3000-mile range impact.

---

## RE-ENTRY BODY COMMITTEE DISCUSSION

"The significant thing is a memorandum dated 27 February in which Dr. Brown has invited the Navy to tell him what the feasibility, the desirability, and the cost factors are for POLARIS participation in this test. At present we are drafting an answer that says participation is feasible but not necessarily desirable. It would be difficult to simulate our re-entry conditions and our Mach number at re-entry is quite different. Finally, it will cost more than the BLUE ROCK test."

Dr. Hartmann expressed some surprise at not having been informed about this projected SLEIGH RIDE test. Commander Julian explained that Lockheed had undoubtedly gotten in touch with NOL people about it.

"Figure 9 is an artistic representation of BLUE ROCK THOR launch from the THOR pad up to its apogee," continued Commander Julian. "On the way down, the four bodies eject at the appropriate velocity so that at about 60,000 feet radar-track will have been established on the trajectories of these bodies. You have launched the NIKE-HERCULES with its nuclear warhead and computed the distance vector and you then detonate the 200 kiloton warhead when the bodies are at the spacing you want. It sounds easy, but it isn't."

"The altitude tolerance on this would have to be about plus or minus a thousand feet, plus or minus two seconds to intercept, so there are problems remaining to be worked out."

"Let me briefly run through some recent changes in our PX-2 program, as scheduled in figures 10 and 11. About four weeks ago, the Admiral approved the shift of A3X-41 and A3X-46 vehicles to the Pacific for PX-2 guidance and missile development objectives, thus increasing the PMR program to six A3X vehicles for PX-2 shots. A few days ago we asked DDR&E to provide the services of the DAMP ship to the AMR during the PX-2 program. We do not intend to buy the ship and crew for this operation but we would like better down-range coverage. As I recall, we asked specifically for the ARIS ship although we do not actually expect to get it."

RE-ENTRY BODY COMMITTEE DISCUSSION

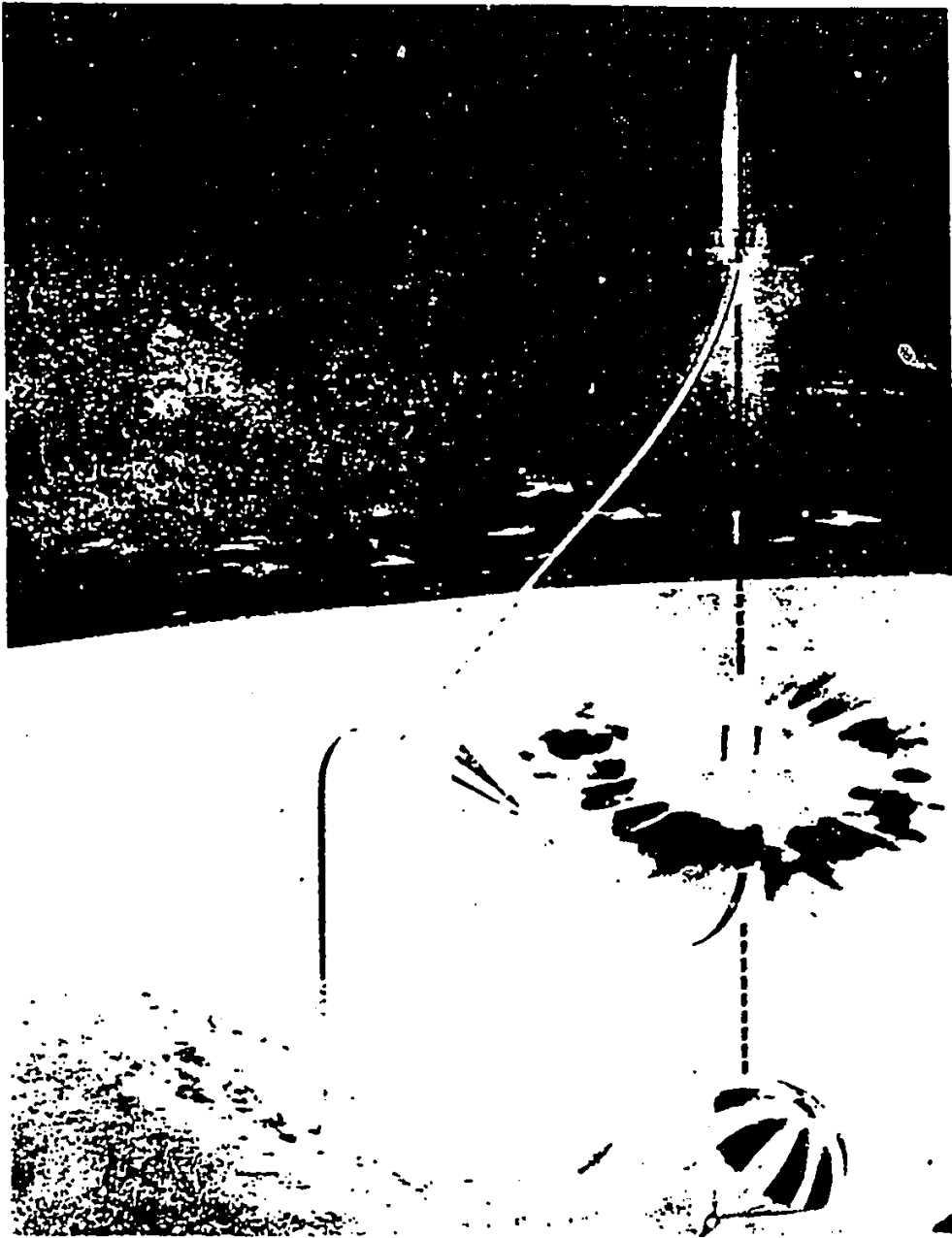

Figure 9

RE-ENTRY BODY COMMITTEE DISCUSSION

PROPOSED A3X/PX-2 FLIGHT TEST PROGRAM									
FLIGHT SCHEDULE (AMRI VEHICLE NO. A3X)	JUN 27	JUN 33	JUL 36	JUL 37	AUG 38	AUG 39	OCT 44	NOV 48	NOV 50
CONFIGURATION PARTIAL KIT FULL KIT	0	0	0	0	X	X	X	X	X
LAUNCH FACILITY FLAT PAD EAG - 154	L	M	S	L	M	L	S	M	M
IMPACT GRAND TURK ANTIGUA BOA 114 <sup>D</sup> KWAJALEIN	X	X	X	X	X	X	X	X	X
D. R. INSTRUMENTATION RADAR FACILITY	DAMP FPS-6 FPS-49	DAMP FPQ-6 FPS-49	DAMP	DAMP FPQ-6 FPS-49	DAMP FPQ-6 FPS-49	DAMP FPQ-6 FPS-49	DAMP	DAMP FPQ-6 FPS-49	DAMP FPQ-6 FPS-49
DECOY (VANE) DECOY (DART) CHAFF REFLECTOR (CR) CHAFF ACTIVE (CA) TRACK PACK (TP)	2  1 1	1  1 1	1  1 1	2  1	5  6 1	5  6 1	5  6 1	5  6 1	5  6 1
DECOY POSITION 1 2 3 4 5 6 CHAFF POSITION A B C D E F	X  TP X	  TP X	  TP X	X  TP X	X X TP X X X	X X TP X X X	X X TP X X X	X X TP X X X	X X TP X X X
					CR CR CR CR CR	CR CR CR CR CR	CA CA CA CA CA	CA CA CA CA CA	CA CA CA CA CA

Figure 10

RE-ENTRY BODY COMMITTEE DISCUSSION

PROPOSED A3X/0X-2 FLIGHT TEST PROGRAM						
FLIGHT SCHEDULE (AMR)	NOV	NOV	JAN	JAN	JAN	JAN
VEHICLE NO. A3X	41	46	53	55	59	60
CONFIGURATION PARTIAL KIT FULL KIT	X	X	X	X	X	X
LAUNCH FACILITY FLAT PAD EAG-154	L	L	L	L	L	L
IMPACT GRAND TURK ANTIGUA BOA 114 <sup>o</sup> KWAJALEIN	X	X	X	X	X	X
D. R. INSTRUMENTATION RADAR FACILITY	ZEUS TRADEX	ZEUS TRADEX	ZEUS TRADEX	ZEUS TRADEX	ZEUS TRADEX	ZEUS TRADEX
DECOY (VANE) DECOY (DART) CHAFF REFLECTOR (CR) CHAFF ACTIVE (CA) TRACK PACK (TP)	6) 6)	6) 6) 6	6) 4 2	6) 2 4	6) 6) 6	6) 6)
DECOY POSITION 1 2 3 4 5 6	X X X X X X	X X X X X X	X X X X X X	X X X X X X	X X X X X X	X X X X X X
CHAFF POSITION A B C D E F		CR CR CR CR CR CR	CR CR CR CR CA CA	CA CA CA CA CR CR	CA CA CA CA CA CA	CA CA CA CA CA CA
* - CHOICE OF DECOY TYPE WILL BE FORTHCOMING						

Figure 11

## RE-ENTRY BODY COMMITTEE DISCUSSION

Captain Jacobs stated that the request specified "a ship" because there is considerable need for ship support for this down-range radar data in the PX program, and there is only one ship at present that can provide it.

"The DAMP, or whatever ship it is," continued Commander Julian, "will supply the impact area radar data to provide two important things for us in the PX-2 program; first, to assist us in selecting between two different decoy designs that we plan to fly on our partial flights; and second, after selection, to examine the flights of the selected decoys, plus the chaff in conjunction with the observations, like TRINIDAD tracker and possibly FQ-6 radar.

"For example, one is a dart, while the other is a dielectric standard configuration decoy. They both have rather large base plates for providing the required cross sections. AMR has made a rather strange finding that they would no longer provide at their expense, data reduction for penetration aid flights; in other words, we have to commit quite a large sum of money to getting the data back from AMR flights of PX-2."

Captain Jacobs clarified this point as follows: "This attitude is not the AMR position, but there is a faction within AMR that wants to handle the data reduction and analysis. We are not certain that the range has this ability, or can gain the ability within the time frame; we do not have to pay AMR for this service. After talking with Lockheed, General Electric, Collins and Federal about the kind of confidence that is needed in the range information, we recommended that the Range not be used for tracking data reduction. We feel that RCA can handle this by themselves."

"The Air Force has an annual budget of approximately \$180,000,000 for Advanced Re-entry Systems Research," continued Commander Julian. "This program does not have any definite goals except a hope that, as time goes by, the Air Force will be able to separate the things that drop out that look good. Both this program and their big BMRS program, which also has a large budget, have penetration aids developments in force.

## RE-ENTRY BODY COMMITTEE DISCUSSION

"We feel that PX-1 penetration aids for the A2 missile were certainly not as sophisticated as they could be, had we elected to take more time to do it. The technology improves as time goes on. Similarly, PX-2 for A3 will not be as sophisticated as we could have made it, given more time and a better technology. However, for B3 and any other advanced systems that POLARIS will send to sea, we will need rather advanced and sophisticated penetration aid techniques and hardware. For that reason, we are proposing the long-term penetration aid upgrading program shown in figure 12. Much of what you see here has been approved by Admiral Smith.

### PENETRATION AIDS UPGRADING PROGRAM

#### I ELECTRONIC DEVICES

- A. R & D - NEW BROAD BAND NOISE TUBES  
(UHF, L, S, BANDS)
- B. BASIC RESEARCH - NEW DECEPTION TECHNIQUE

#### II CHAFF/INERT RESOLUTION CELL SATURATION TECHNIQUES

- A. IONIZING PELLETS
- B. CHAFF PARTS
- C. PX-1C WSMR FLIGHT TESTS
- D. PX-2C PMR FLIGHT TESTS

#### III OTHER EFFORT

- A. FULL SCALE ANACHOIC CHAMBER AND OUTDOOR CROSS SECTION FACILITIES - LMSC
- B. GASL THERORETICAL WORK: WAKE PREDICTION - CROSS SECTION CORRELATION/NOL
- C. NWL COMPUTER ENGAGEMENT MODEL
- D. NESCO - ADVANCED CONCEPT FEASIBILITY
- E. NOL AERO BALLISTIC WORK - 1000' RANGE
- F. CONDUCTION CROSS SECTION REDUCTION TECHNIQUES

Figure 12



## RE-ENTRY BODY COMMITTEE DISCUSSION

"In the PX-1 package we have two jammer packages which are radiating at L- and S-bands to jam the acquisition and tracking radars of our assumed defense model. There are improvements we can make in the cavity resonators which provide the noise spectrum: we can improve their band width; we can improve their power density, that is, the total number of milliwatts or watts radiated per megacycle; and we can extend the band width to cover a broader band at some central frequency. We can and will do this at L- and S-bands because we are still convinced it is in that region that acquisition and tracking will probably be conducted.

"We are concerned as well about the UHF threat. There are tubes now under development which can give us a UHF band jamming capability. By duplexing the present tube, we can cover from 250 to 600 and possibly up to 800 megacycles. With new antenna and system designs it is hoped that we can increase the power density to levels four and five times greater than our present system, PX-1E, possesses. This development is going ahead as also is the basic tube development to prove the new tube designs. We will do breadboard and prototype system development.

"I should like to recommend that we proceed carefully with this development. It is possible that some severe system design changes may result from these efforts, and if we go to tactical hardware, we would then have to underwrite a T&E program with some expensive flight testing in it."

"Just a minute," said Admiral Smith. "If you are convinced the Russians are using L- and S-band radar, why all this concern about UHF? Will they be using both?"

"Evidently they will," replied Commander Julian, "for there are some UHF radars apparently around Leningrad now operating in the region from 200 up to 800 or 1000 megacycles. Now this is a troublesome region if there are radars there, because we have no capability at these low frequencies. It is difficult to make good chaff at such low frequencies. The design problem is difficult there as well.

## RE-ENTRY BODY COMMITTEE DISCUSSION

"The Russians have problems too, because at low frequencies there may possibly be a severe radar problem due to nuclear blackout. Perhaps they will make some compromise in the choice of frequency on the basis of nuclear blackout and what they hope a UHF system will do. If we can develop a UHF system with a band width from 200 to 800 megacycles, a new L-band system from 900 up to 1600 megacycles, an S-band from 2300 to 3600, we will almost be able to cover the whole radar spectrum from 200 megacycles up to C-band. I think this is a very desirable goal.

"I do not think we should go into production on these systems as yet, not even when the tube development and the system prototype have been proven, until we know more from the defense intelligence people about the frequencies we should be jamming."

Captain Sanger observed that a hole in the coverage existed between 1600 and 2300 megacycles, and Commander Julian explained that this was an area that had not as yet been used for radar coverage.

"You mean, an area that we have not used," replied Captain Sanger.

"I grant you that there is no reason why it might not be used," replied Commander Julian, "but these defense models are basically predicted upon our abilities and the assumption that the Russians have the same abilities.

"Getting back to the data on that last figure, we have a small research contract out on a very new signal delay technique. If it proves successful, we will be able to package deception devices which will be able to give 50 to 100 false targets and respond to a pulse-to-pulse frequency change to the interrogating signal. I do not want to say more about that at this time.

"We have a promising proposal on hand to use ionizing pellets instead of chaff as an inert resolution cell saturation technique. I think I showed you one of these foil-type arrangements about six months ago.

## RE-ENTRY BODY COMMITTEE DISCUSSION

We feel that wires are somewhat inefficient to use for this type of coverage. There may be a way of combining the characteristics of chaff wire and a light decoy for better coverage of resolution cells to a lower altitude. With wires alone, this is very difficult.

"As I explained earlier, we have these White Sands tests proceeding now with the SPEEDBALL rockets. This summer we are planning some flight tests with the PX-2 chaff packages at PMR, because the ZEUS complex will have been shut down at White Sands in late May. We can not mount these tests before June or July; by that time we will no longer have ZEUS radar at White Sands, and particularly no L-band coverage there.

"We are proposing to give the PMR tests to the ZEUS people as a target vehicle project and let them run it for us. The rockets are cheap, the logistics is only a little more complex than at White Sands, and we will have the two important radars there -- UHF on both PRESS and ZEUS, L-band on the Tradex, and C-band on the ZEUS."

In response to questions from Admiral Smith, Commander Julian explained that the PMR tests would involve chaff packages flown on the PHOENIX rocket and would take place in the Kwajalein area.

"They will launch vertically from Roi," continued Commander Julian, "and come down vertically on the south end of Kwajalein. We are pretty well forced to this, because they are shutting down the radars at White Sands that would give us valuable information.

"We are providing increased radar cross-section facilities as a part of this general program of updating penetration aids. This will be a full-scale anechoic chamber which will be able to measure cross-sections over a wide frequency band. We also have theoretical work proceeding on the prediction of the frequency content and electron density of wakes. The General Applied Science Laboratory is working on this and will try to develop a radar cross-section correlation based upon wake prediction.

## RE-ENTRY BODY COMMITTEE DISCUSSION

"Initial tests at NOL suggest a close agreement between the wake patterns and GASL's predictions for a body, which supports the idea that theoretical prediction will have some value here. The Naval Weapons Laboratory is working up a computer engagement model for our defense studies which will give us a much more sophisticated working model than we could get working these problems out by hand. They have already worked up some basic pieces of the model program.

"NESCO (National Engineering Science Company) is studying advanced penetration techniques. They will investigate these concepts up to the point of engineering feasibility which will be handled separately by Lockheed.

"We intend to use the NOL aero-ballistic range and personnel for an improved decoy development. We have a small contract with Conductron Corporation to try out the ferrite absorbers that they are developing. We can possibly reduce radar cross-sections several orders of magnitude by the use of this material. I think it is worth looking into, as does the Air Force, which has backed this program with a good deal of money.

"Dr. Sigel claims that this material can be effective across very broad bands. He is also developing a design that will look like an Eaton lens to any radar. Such a technique would show an identical zero cross-section to any radar at any frequency. It seems a bit hard to believe.

"The design would be incorporated into the re-entry body structure, so it is a matter of several years lead-time -- as much as would be needed to develop an entire new re-entry body structure."

"This will not require any agreement with the Russians about the exact radar band frequencies they will be using in three years, will it?" inquired Admiral Smith.

---

## RE-ENTRY BODY COMMITTEE DISCUSSION

"Not at all," replied Commander Julian, "for Dr. Siegel is developing composite layers, and each layer will be sensitive over a very broad band.

"One thing more on PX-1: I mentioned earlier that we need some firm guidance on how to put the Y2 warhead to sea. We also need firm guidance on how to put the PX-1 system to sea. Our present plan is to buy 221 tactical PX-1 systems to equip all A2P missiles in the Fleet. This figure includes new submarine loads and the retrofit of all others. At a recent meeting with the Fleet, we learned that they did not want to go to sea with a total load of PX-configured missiles. They were thinking in terms of having a few tubes per boat configured with PX missiles and this would be on top of the 50-50 split of Y-1 and Y-2 warheads. We need to know what to tell NWA to do beginning with SSB(N)618 and SSB(N)616. We intend to bring this question up at a new meeting proposed for April.

"We have a serious problem here," said Dr. Wilson, "and we have not laid plans to attack it adequately. We have a potentiality of eight different configurations of the A2, considering two different warheads with and without PX and with and without PY. We have got to do some paper work to provide information to the submarine commander on fire control because he will be forced to set targetting on a tube-by-tube basis. I realize the Y1 and Y2 choice will not affect fire control except in the selection of target. Handling this problem at the spot knob may be an unnecessary complexity."

"I am more concerned," said Admiral Smith, "with the problem in interchanging Mod 0 and Mod 1 warheads."

"When I wrote the report," answered Commander Julian, "we could not do the interchange. The problem is one of flare interchange. We have asked Lockheed to develop an adapter kit that will make the interchange possible. This adapter is the minimum step needed if we are going to respond to the need for an option to put on all or none."

## RE-ENTRY BODY COMMITTEE DISCUSSION

"Will this mean two logistic alternatives for the tender?" asked Captain Thompson.

"We are going to propose it," replied Commander Julian. "We can treat the PX kit as a wooden system assembled at NWA or we can build a new container which will accept a totally assembled Mark 1 Mod 1 system including an extension ring, all assembled parts, and AFD. Once aboard the tender, it might be removed and stored bare.

"This has not yet been discussed thoroughly by the Safety group. They have looked at transportation of the assembled system, but I do not believe that they would approve long-term storage of a Mark 1 Mod 1 system with the AFD installed which contains the battery and all the pyrotechnics in place and connected.

"This is just one possibility. This is a wooden technique because the tender people do not have to do anything to the system in order to exchange a Mod 1 for a Mod 0. If they take anything apart when they get it, then they will need all kinds of alignment tools and checkout procedures; the operation will get very complicated.

"Another possibility is to do it as we originally planned: ship them a Mark 1 Mod 1/2 re-entry body which will have the AFD and the equipment rack in, but not the pyrotechnics. We also would ship them at the same time the extension ring in its own container, and we would ship the pyrotechnics and the decoys and so on in separate containers. When these get to the ship, we would provide some storage for a certain few components. When the time comes to make an exchange, the re-entry body shop on the ship will then have to build up a system. This is not an easy job, as we discovered during the logistic evaluation; it is a very time-consuming and demanding job. The tender skipper and COMSUBRON 14 do not like this idea at all. The solution depends on what the Fleet wants to do with the system. We will present both these two logistic proposals at the meeting in April."

## RE-ENTRY BODY COMMITTEE DISCUSSION

Asked about the flare interchange, Commander Julian explained that it would be a fairly simple alteration that could be handled easily at NWA or on the tender. Captain Dubyk observed that the last time this problem was discussed, there was concern about an interfering bracket, and Commander Julian said that he would produce the design as soon as possible for Admiral Smith's consideration.

"How much time is needed to make the change," asked Admiral Smith, "once a decision has been made about the numbers of each type needed?"

"The modification will take about one working-day per re-entry body," replied Commander Julian, "working in a single-line REB shop."

"Once we get all these kits," observed Admiral Smith, "NWA will still need about one month's notice before the outloading of a submarine or an AK shipment."

"There is also a problem at the other end," added Commander Julian, "when the submarine comes in for a total fit-out. There is a great deal of work to be done, and it does not seem possible to transfer 16 PX systems and get all the other work done during a normal 30-day availability period at the tender."

"The Fleet does not want 16 in any one hull," added Captain Thompson, "but only 3 or 4."

"Basically, I think the Fleet wants as much ability as they can get in changing these things," observed Admiral Smith.

"The only easy plan we have seen on this change requires that the SSB(N) return to NWA for retrofit," said Commander Julian in concluding his report.

RE-ENTRY BODY COMMITTEE DISCUSSION

After a very brief review discussion of some of the points in the report, Admiral Smith called a luncheon recess.



FIRE CONTROL AND GUIDANCE  
COMMITTEE REPORT DISCUSSION

"For my presentation of the Fire Control and Guidance Report," began Captain O'Neil, "I should like to take up the systems in this order: the Fire Control System Mark 80, the Guidance System Mark 1, the Fire Control System Mark 84, and the Guidance System Mark 2.

"With the last of the Mark 80 systems being deployed now, we have not seen much activity in this area. Satisfactory reports keep coming in from the Fleet, and our only concern at present is with the conversion kits for the 598-Class."

"Are these satisfactory reports coming in because the Fleet does not test the equipment?" asked Admiral Smith.

"On the contrary," replied Mr. Parran, "the equipment is getting tested far more than we had ever intended. They simply do not turn it off."

"Well, there are some things that cannot be tested because of safety restrictions are there not?" asked Admiral Smith.

"That is true only in particular areas," answered Captain Styer, "but in most areas the equipment is running all the time. We have continued to make replacement of spares and the like while on patrol, not because of specific tests as much as because of indicated needs during normal running."

"We see the TFR's as they come in on the Mark 84," said Mr. Mitchell, "and I could wish that we did not have so many. We are in the early stages on this equipment and are doing a lot of testing."

## FIRE CONTROL AND GUIDANCE COMMITTEE DISCUSSION

"You will never get TFR's on equipment unless someone is looking at it," replied Admiral Smith, "and there are areas in this equipment that cannot be looked at."

"We have the same problem with the missile," agreed Captain Styer, "for we have found that there are some things and certain circuits that cannot be tested. On the SSB(N)599 we found a broken lead in the fire control switchboard; unless we went through that particular operation, we would never have found this failure."

"How about devising test programs that will safely check these areas that we are not now looking at," suggested Admiral Smith, "such as a technique for running the count down to ten seconds?"

"That is as far as you dare go," observed Captain O'Neil.

"It is a lot further than we would previously have dared to go," replied Admiral Smith, "until people started thinking about the matter. Another possibility is during Sabot launchings which, if they are worked out properly, will give us an opportunity to exercise those parts of the system that are unsafe to exercise with a missile aboard."

"Regarding the 598-Class conversion schedule," continued Captain O'Neil, "at present we have the SPALT kits to alter the Mark 50 equipment for the A3 Mark 2 conversion. This kit has already been developed and it is only a matter of cleaning up the system and getting it into production.

"The other area is the target card computer which does not have a tie-in with the overhaul but which has been planned to run at the same time. Vitro has a specification for this computer system and Mr. Mitchell will give you a rundown on that if you wish, and answer any questions. We intend to put this target card computer in the area originally designated for target card stowage. We will say more of this later.

## FIRE CONTROL AND GUIDANCE COMMITTEE DISCUSSION

"The next item is Guidance System Mark 1 production, shown on figure 1. You can see that we are already in the throes of phasing out the Mark 1 guidance system. Starting with the letter 'A', which is early in 1963, Minneapolis-Honeywell goes out of production on the IRIG's and at 'B' they are scheduled to start production on the PIG's in April and continuing down the line until we go out of production on the various inertial components. Later we will shut down on the electronic packages and finally on the final delivered assemblies. We are scheduled to terminate in December with approximately 700 units delivered. Of these we will probably have about 550 operable units, as the others will have been destroyed or seriously damaged.

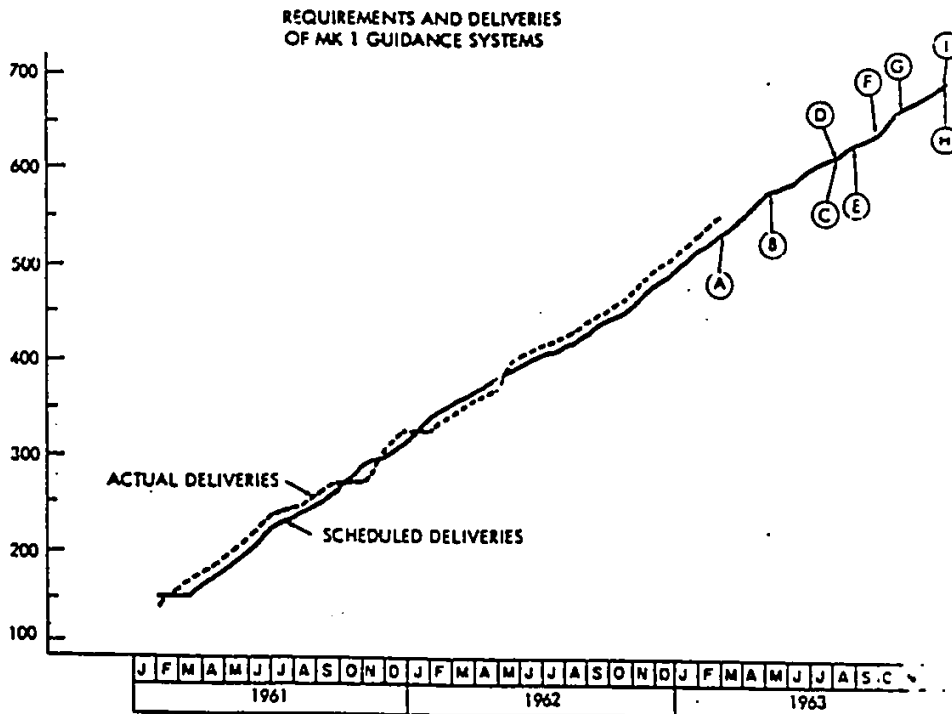

Figure 1

## FIRE CONTROL AND GUIDANCE COMMITTEE DISCUSSION

"The other problem has been the return and repair rates of the Mark 1 units. We had anticipated the return of about 1.6 capsules per boat per month, and the return rate has been holding at 1.3 until last fall when it began to crowd 1.6. When it did hit 1.6 units, we tightened up on some of our testing and established good failure rates. People had been counting failures at different rates as to when one system arrived at NWA or when it was rejected. We finally have steadied this and are now running about 1.3 capsules per boat per month.

"Regarding our factory rejects, we have organized a team to go around and calibrate the equipment at the production plant and at NWA. Last fall we were running somewhere in the order to 25 to 30 per cent rejects between the factory, NAFI and NWA; at present we are down about 13 per cent. We still have work in this area but things are getting better. When we get into Mark 2 production, we hope to remove this problem by giving the plant and NWA identical pieces of test equipment. This should reduce rejects from the other facilities after the equipment has left the factory.

"Concerning the Mark 84, figure 2 shows a production schedule and should give you an idea of where we stand.

"We will probably never achieve the 12 months prior to ready for sea date, although we will continue to try. We have pulled up all the loose ends and are now at the point where we would have to move the entire program. However, on the first boat, the SSB(N)616, we delivered in August and finished checking the AIM missiles dock-side in about six and one-half months.

"However, the shipyards still have problems, for they anticipate having these pieces of hardware by the 12 months prior to ready for sea date. Even though they probably will not use them, they like to have the pieces in-house. We did have one system at Mare Island and actually put it into the shed for about two weeks. Generally, we will not be able to brag at all until about January or February of 1964.

FIRE CONTROL AND GUIDANCE COMMITTEE DISCUSSION

MK 84 FCS  
SSBN 616 CLASS  
DELIVERY SCHEDULE

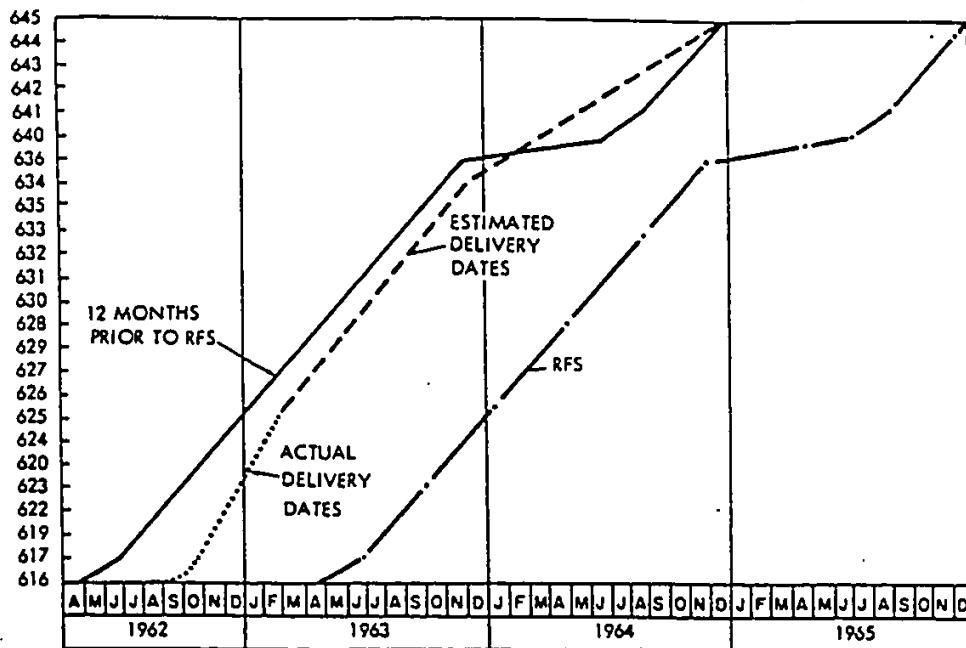

Figure 2

"In the meantime, our biggest problem is getting the SSB(N)616 squared away, as there are about 40 SPALT's to date, varying from changing labels and putting guards on switches, to running some of the sneak circuits that developed when we tied in the other pieces of equipment to the Mark 84. We accomplished 18 of these in the last two-day dry-dock period and will accomplish 20 more in the next four days' schedule. At present, things are well in hand, but new SPALT's are still occurring and we expect another 15 or 20 before the SSB(N)616 is deployed. We feel that we will be able to take them all in stride and accomplish this.

"One other interesting item about the Mark 84 is the fact that we now have a go-ahead on procurement action to buy one engineering model of the Mark 84 which we will leave at GE to try out all SPALT's, engineering changes, and any other thing that might occur.

## FIRE CONTROL AND GUIDANCE COMMITTEE DISCUSSION

"Our next area is the Mark 2 guidance system. We have produced about 35 systems to date and are now going through production pains similar to those we went through on the Mark 2 systems. We have had some experience that might attest to the ability of this system to withstand environmental testing. Figure 3 shows the two capsules that survived an airplane crash in San Francisco last month. One was extensively damaged and the other one was heavily charred.

"Figure 4 shows a guidance package whose container broke. It might be interesting to know that although the electronics package was pretty well bent out of shape, it still worked; the ball did not succeed quite so well.

"Figure 5 is a view of the inside of the container that held the good package and figure 6 is a view of the system that is still usable. It survived the crash, although we do not know how many g's it withstood."

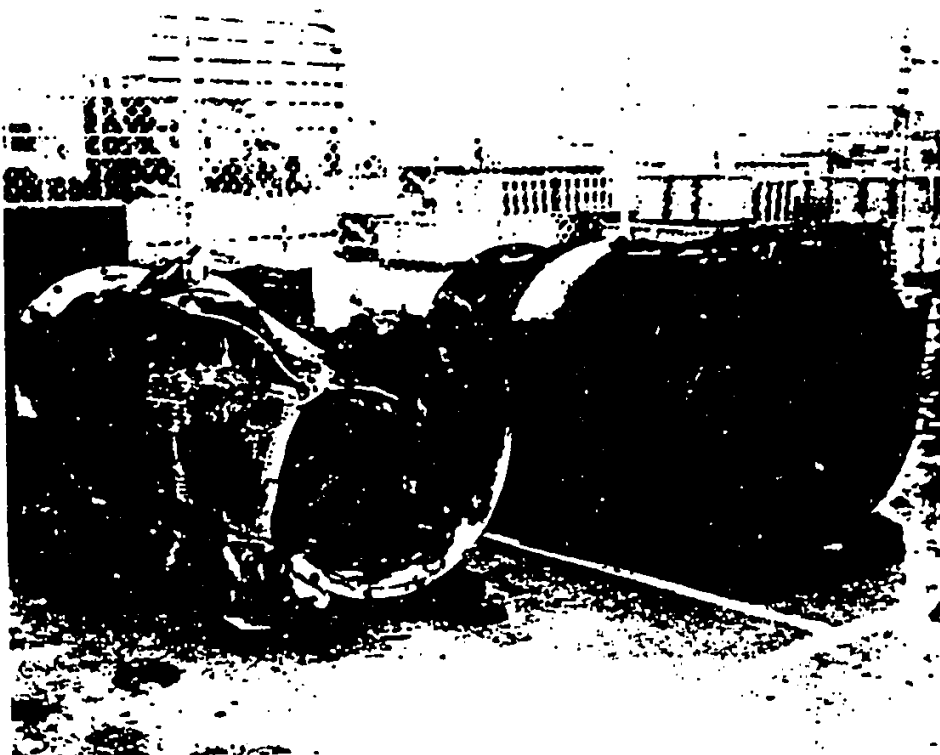

Figure 3

FIRE CONTROL AND GUIDANCE COMMITTEE DISCUSSION



Figure 4

FIRE CONTROL AND GUIDANCE COMMITTEE DISCUSSION

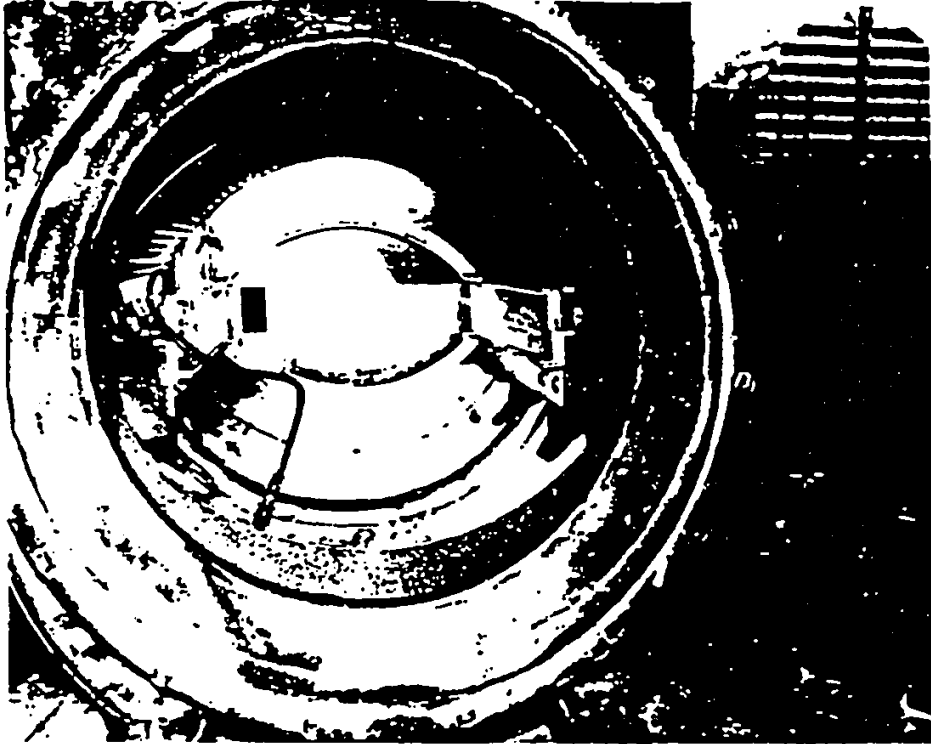

Figure 5

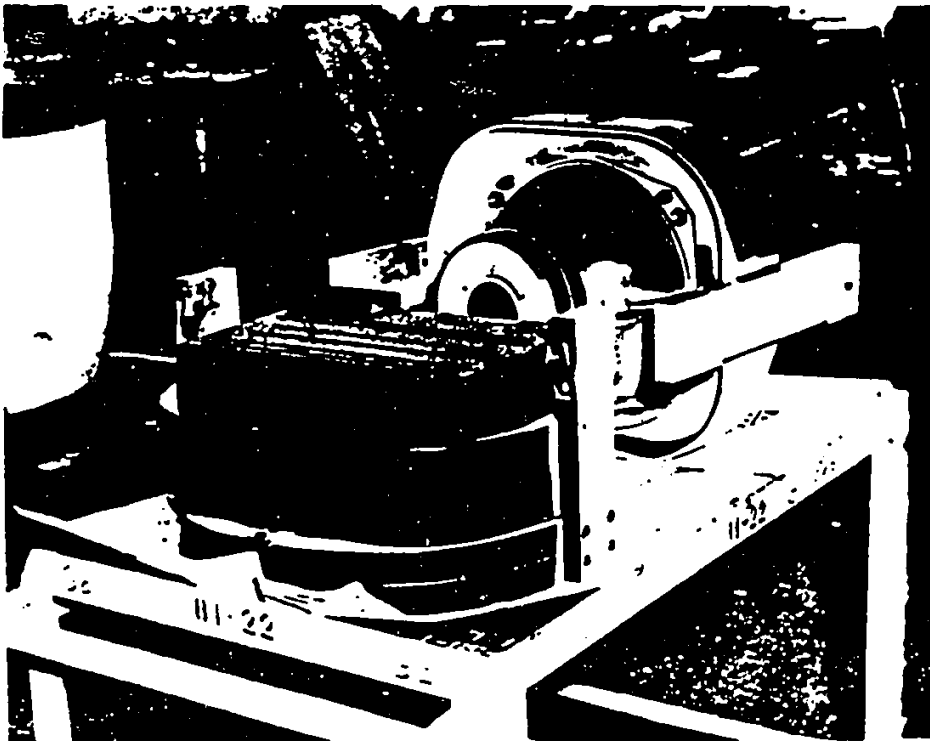

Figure 6



## FIRE CONTROL AND GUIDANCE COMMITTEE DISCUSSION

Mr. Peterson mentioned that the courier was one of four surviving the crash . . . a man named O'Neil.

"I would like to know more about the TFR's on the equipment," said Admiral Smith, "and whether there have been any comparisons between the TFR's on the Mark 80 and the Mark 84 equipment."

"I do not know the history well enough to answer, Admiral," replied Mr. Mitchell, "but I do know that on the Mark 80 we only received a monthly compilation of the TFR's from General Electric, and the flow did not pass through SP23 as it does now. We had some pretty significant figures in the early days, but the failures have fallen off to rather small figures now. Similarly, a great many SPALT's were executed, but again I cannot compare numbers."

"As I recall," added Captain O'Neil, "the SPALT's ran two or three times what we have on the Mark 84."

"In the early days, the failures, as I recall, were largely concerned with deficiencies in the minutia of design," observed Mr. Parran, "and we could well expect that they would be, considering the work we were doing. Most TFR's were concerned with the corrections needed to make the Mark 80 operate correctly. We get a different kind of failure reporting on the Mark 84, partly because we have run the gamut once before and partly because only one system has been through Phase 4 testing. In addition, the Mark 84 system contains many new pieces and is entirely different in terms of its mechanical design. This change has contributed to the TFR's, but I am not sure that we can make significant comparisons between the systems yet."

"As I recall," said Mr. Buescher, "on the Mark 80 we got from three to four times as many reported failures."

## FIRE CONTROL AND GUIDANCE COMMITTEE DISCUSSION

Mr. Morton asked about the effects of aging on the IRIG's and other units in the guidance capsule. Mr. Forter replied that aging seemed to have no marked effect, but that the age of the system was more important than its service or duty life in that the older systems are simply not as good as the newer ones. Captain O'Neil added that nothing suggested that the older ones were getting any worse with time.

"The population we are talking about here is rather unusual," observed Mr. Parran, "because a guidance system loses its identity gradually. It may be several years old and still have no part in it that is more than so many months old. It is constantly being tested, weaknesses are found, and the needed replacements made. There is no way to say that it is old ... we have not yet seen a trend of old gyros failing."

"Could a fraction of this population stay out there forever?" asked Admiral Smith.

"There is constant recirculation," answered Mr. Parran.

"The oldest capsule comes back after each patrol as part of a surveillance program," added Mr. Forter, "although in one case a capsule had been on board so long that the crew had formed a sentimental attachment for it. We practically had to steal it."

"There is also a difference between the oldest capsule and the capsule that they want to get rid of," noted Captain O'Neil.

"My point is still this," continued Mr. Parran, "that each time something goes wrong with a guidance system in the plant, NWA, the tender, or the ship, corrective actions on that system will make some part of it younger. Only the ones that never fail a test get totally older. The only way we have of tracking this is to examine figures like the mean-time-to-failure for specific guidance systems. The trend is good; the systems get better."

## FIRE CONTROL AND GUIDANCE COMMITTEE DISCUSSION

"If you want to play a numbers game," added Mr. Forter, "then this mean-time-to-failure can indicate an expected life. However, there is no mathematical truth because frequently the good ones stay good and the bad ones drop out."

"The inertial components see their biggest fall-out during the first 60 days," said Captain O'Neil.

"Are we going to be able to pull a Mark 2 off the line and run it through the acceptance test a number of times?" asked Admiral Smith.

"We are so close to the line that we do not have any extras," said Mr. Peterson, "although we are not pushed the way we were with the Mark 1."

"At present, the guidance systems go through assembly and intermediate testing to the point of the final system test," explained Mr. Parran, "and all failures are fixed right up to that point. We have not yet missed a delivery due to failures."

Admiral Smith noted that the production test equipment was not yet available, but that when the equipment was on hand it would be highly desirable to pull a system every once in a while and run it through the tests quite a number of times. Mr. Forter agreed, explaining that even now system No. 30 had been in Pittsfield for some time for the full round of tests that GE was running, and that it would soon move on to MIT for an additional round of testing; GE had allowed time in its schedules to pull units for a thorough evaluation before delivery to Lockheed.

Captain O'Neil explained that the procurement of inertial components was done only after much testing in the producer's plant.

## FIRE CONTROL AND GUIDANCE COMMITTEE DISCUSSION

"How about the future?" asked Admiral Smith.

"Up to mid-1965, we are close to the line of supply meeting demand," replied Mr. Parran, "but after that date we will be able to hold out quite a few systems for additional testing."

In response to questions from Mr. Morton, Mr Forter explained that the inertial unit production for Mark 1 systems would be stopped as indicated earlier, but that the necessary repair and rework lines will stay in operation as long as there is a need for them, and that only the units which have broken up completely will be thrown away without repair, rework or rebuilding.

At this point, Captain O'Neil introduced Mr. Mitchell for a discussion of the target card computer system.

"The Target Card Computer System is a device that we propose to add to the 598-Class," began Mr. Mitchell, "to generate the target cards at sea. It will replace the rather cumbersome technique of rotating cards or microfilm from Dahlgren which we now use.

"The target card is used to supply target input functions to the Fire Control System Mark 80 in conjunction with certain hand-set quantities on the target data input units. The card performs a vital function in the parity checks that are necessary for the target set-ups. Each card contains data for one target based upon a launch reference square of 20 miles on a side. The library problem associated with these cards at present is becoming unmanageable with the increased number of targets assigned to POLARIS submarines and the increasing numbers of launching positions. With these two increases, it becomes rather desirable to generate the cards at sea for all targets that the submarine might strike.

## FIRE CONTROL AND GUIDANCE COMMITTEE DISCUSSION

"The card generation involves the use of a computer to handle the rather complex guidance equations together with a good memory system to store all the target data required for burst height, and the longitude and latitude of the reference point, launch point, and target point.

"Each target card contains 28 printed and 10 punched quantities which will be determined and placed on the card by this new card system. These 38 entries are based upon the initial input of target number and launch reference point, supplemented by the burst height and the various latitude and longitude data. All the storable data will be recorded on the target data input tape. At present we are using an aluminum-backed Mylar tape for this purpose; the tape is eight columns wide and can contain all the target data necessary for slightly less than 1000 targets per reel. We will probably be carrying more than one reel of this tape.

"The information on the mylar tape is entered into the program of the target card computer by transfer to a program tape by an ordinary punch tape reader. This program tape will also contain entries that do not come from the tape storage bank. The missile type, for example, is a function applied to the program tape in order to introduce the appropriate ballistic equations for a specific missile type.

"Once the program tape is entered, it is removed from the tape reader and the information on the target tape is entered through the same tape reader to the memory system. The operator merely indicates the target number, launch reference point, and the longitude and latitude data for as many as eight target cards at the same time. The limitation of eight is imposed by the memory system in part, but it is also the maximum number of target data input units available on the Mark 3 fire control system.

"Following storage of this data in the computer memory, the computer then types out the contents of its memory on a check sheet. This allows the operator to verify that the computer understands the input information and has it correctly stored. We have designed several such checks in this system.

## FIRE CONTROL AND GUIDANCE COMMITTEE DISCUSSION

"As soon as the check is completed, the computer begins a forward search of the target data on the perforated tape to obtain the burst heights and the longitude and latitude readings for each of the eight targets specified to the computer by the operator. Next, the computer begins the calculations of the various quantities that are printed and punched on the target cards; these calculations are made with the appropriate guidance equations for the specific missile type.

"The operator then places a blank target card in the computer's typewriter output. He waits for an indicator on the console to show him that the printed matter has already been computed; when the indicator appears, the operator switches the typewriter to ON and the computer types out the target data on the card. This is the same material that normally appears on the target cards today. This typewriter has an echo capability which sends each printed digit or letter back into the computer where the computer verifies that the symbol is the same one that was sent out. We hope in this manner to prevent any chance of garbled data by verification at this point.

"The operator now pulls the card from the typewriter and places it in the card feed of a punch device where the computer will punch the entries required on the card. (While this is going on, other areas of the computer are solving for the other card inputs.) Then the first card is read back into the computer for verification and completion of an inverse check calculation. This calculation is very much the same as that in the Fire Control System Mark 84; the results of the computations will be read back into the computer, whereby they, as independent variables, are used in a set of equations stored in the memory circuits, to arrive at the input quantities, which now have become the dependent variables. These computations are read out and checked against the original inputs.

"Now as soon as the inverse check of the first card is finished the computer then types out material for the next target number, launch reference point and so on. The operator will remove the first card and either put it into a finished target card file or send it ahead to the Missile Control Center.

## FIRE CONTROL AND GUIDANCE COMMITTEE DISCUSSION

"We have specified that the computer be able to generate one checked and proven card per minute. This is generous because a skilled operator will be able to increase the speed substantially. The target cards themselves, of course, do not have to be stored unless this is desired; they can be destroyed as storage space is needed because it is a reasonably small matter to print up another one at any time."

"Will this computer be able to give you target cards for targets that had not previously been planned?" asked Captain Thompson.

"Yes, it will," replied Mr. Mitchell, "for it will be able to handle data taken from microfilm or even from radio transmission. One of its greatest virtues is its ability to create target cards under such circumstances."

Dr. Craven asked about the ability to check from the target number as typed on the final target card back through the system. Mr. Mitchell did not have the information to answer that question at that time. Later it was determined that such a check was entirely possible and would be incorporated into the system.

"How about procurement on this?" asked Captain Styer.

"We plan to use available equipment to make up this system," explained Mr. Mitchell. "The computer and the arithmetic and memory system of the proposed computer subsystem will be adaptations of presently established computer devices. These will be specified according to their availability in the Navy Supply System. We have been considering items of the Mark 84 system hardware, such as the DGBC computer or something like the NTDS as an over-all system. We feel that the development will not be more than 10 per cent of the over-all effort."

## FIRE CONTROL AND GUIDANCE COMMITTEE DISCUSSION

"Similarly, the peripheral equipment will largely be already developed items. The original design work will encompass only the console, interconnecting cables, and the installation arrangement.

"The space required will be about the same as is now required for target card stowage. The console itself will be very small. The operator panel will present a duplex system for the two separate and distinct target card computer systems. It will not have any elaborate operator panel arrangement. The system itself will be completely duplexed, i. e., two computers, two operator panels, and the like, each having the capability of generating the requisite number of cards per minute.

"Two of the first four systems produced will be supplied for training purposes; one will be sent to Dam Neck and the other to New London."

Asked about functional interfaces, Mr. Mitchell explained that there were none except for a power supply, space requirements and weight; if necessary the equipment could be installed by the tender although this would be a big job for the tender crew to handle. The entire computer package has been designed to pass through a 25-inch hatch.

With no further discussion, Admiral Smith called upon Commander Hammerstone for presentation of the Launching Committee Report.



## LAUNCHING COMMITTEE REPORT DISCUSSION

"In the previous meetings," said Commander Hammerstone, "we usually reviewed the status of the launcher development and the launcher production program. Since the Mark 21 Mod 0 and Mod 1 launcher developments are completed, and we are well into our production program with no serious problems at this time, I would like to review the general condition of the launcher system hardware in deployed submarines and comment on the comparison between requirements imposed by actual operating conditions and those envisioned in our original specifications. I will confine my remarks to the hardware for which SP22 has direct responsibility. I will not comment on items for which SP22 is not responsible, such as the breather valve, hatch operating mechanisms, and others.

"Two criteria exist for measuring the performance of material in the FBM mission: first, the ability of the equipment to remain in the required state of readiness for missile launching; and second, the time and effort required by the crew and tender personnel to keep the equipment at this level of readiness.

"The launcher system has met the readiness requirement. In some cases, however, the launcher has been a source of steady employment to the crew and tender personnel especially during the upkeep periods. As operational problems developed, it has been necessary to make certain component design changes. In retrospect, some of these problems should have been predictable, but due to the accelerated program it was necessary to proceed with the best design available at the time. At present, a SPALT program is in progress to eliminate the current problems and to update various components with the best designs.

LAUNCHING COMMITTEE DISCUSSION

"Figure 1 shows the operational status of the first 29 ships. The 598-Class ships are deployed with the Mark 15 launcher. They have made a total of 38 patrols as of 10 March. There are three ships of the 608-Class deployed for a total of 8 patrols.

"While covering the operational experiences and problems of the 598- and 608-Classes, most remarks will pertain to the 598-Class because of its greater operating experience.

	<u>SSBN</u>	<u>NO. OF PATROLS COMPLETED</u>	<u>PRESENT STATUS</u>
MK 15 MOD 0	598	9	OUT ON 10th PATROL
	599	9	OUT ON 10th PATROL
	600	7	7th UP KEEP IN PROGRESS
	601	7	OUT ON 8th PATROL
	602	6	OUT ON 7th PATROL
MK 17 MOD 0	608	4	OUT ON 5th PATROL
	609	2	2nd UP KEEP IN PROGRESS
MK 17 MOD 1	610	1	OUT ON 2nd PATROL
	611	1	1st UP KEEP IN PROGRESS
	618	0	AT SDAP
MK 17 MOD 2	616		}
	617		
	619		
	620		
MK 21 MOD 0	623		}
	624		
	625		
	626		
MK 21 MOD 1	627		}
	628		
	629		
	630		
	631		
	632		
	633		
	634		
	635		
	636		
			UNDER CONSTRUCTION

Figure 1

## LAUNCHING COMMITTEE DISCUSSION

"Figure 2 shows the concept of the 598-Class launching system. The left-hand launcher shows the outer or mount tube which is an integral part of the pressure hull. The right-hand launcher shows a cutaway of the launch tube, suspended on liquid springs for shock absorption, and lockout cylinders for hardening the launch tube during launch. At the upper and lower ends of the launch tube are the intertube seals, rubber seals to prevent water from entering the annular space between the launch tube and the mount tube. While not visible in the figure, a diaphragm fits across the top of the launch tube to prevent water from entering prior to launch. In the middle level are the operating and control panels. The lower level has the spherical launch flasks which stow the compressed air for launch energy, the launch valve, and the eject pipe which connects the launch valve to the eject chamber.

"The heart of the launcher system is the eject system, shown in figure 3, including the air flask and the eject service package which charges the air flask and also the launch dome, and controls the intelligence to the launch valve. Also visible are the launch valve eject pipe and diffuser.

"Referring back to figure 2, we expected that sea water back-flooding would enter the eject chamber and the lower part of the eject piping. In some cases, due to operational errors, not only was the eject pipe flooded but also the launch valve and the air flask. We found that the entry of dirt and debris into these areas was more pronounced than we anticipated at the outset. Corrosion in the eject pipe and in the launch valve is still a continuing problem with these ships.

"We have tried various methods of cleaning the eject pipe, including wire brushing, acid pickling, and steam cleaning, while preservation methods tried have included flushing compounds and various paints. The most successful has been a proprietary paint called Rustoleum which we have discontinued because of its suspected toxic hazards. As of now, we do not have a completely satisfactory procedure for maintaining the eject pipe.

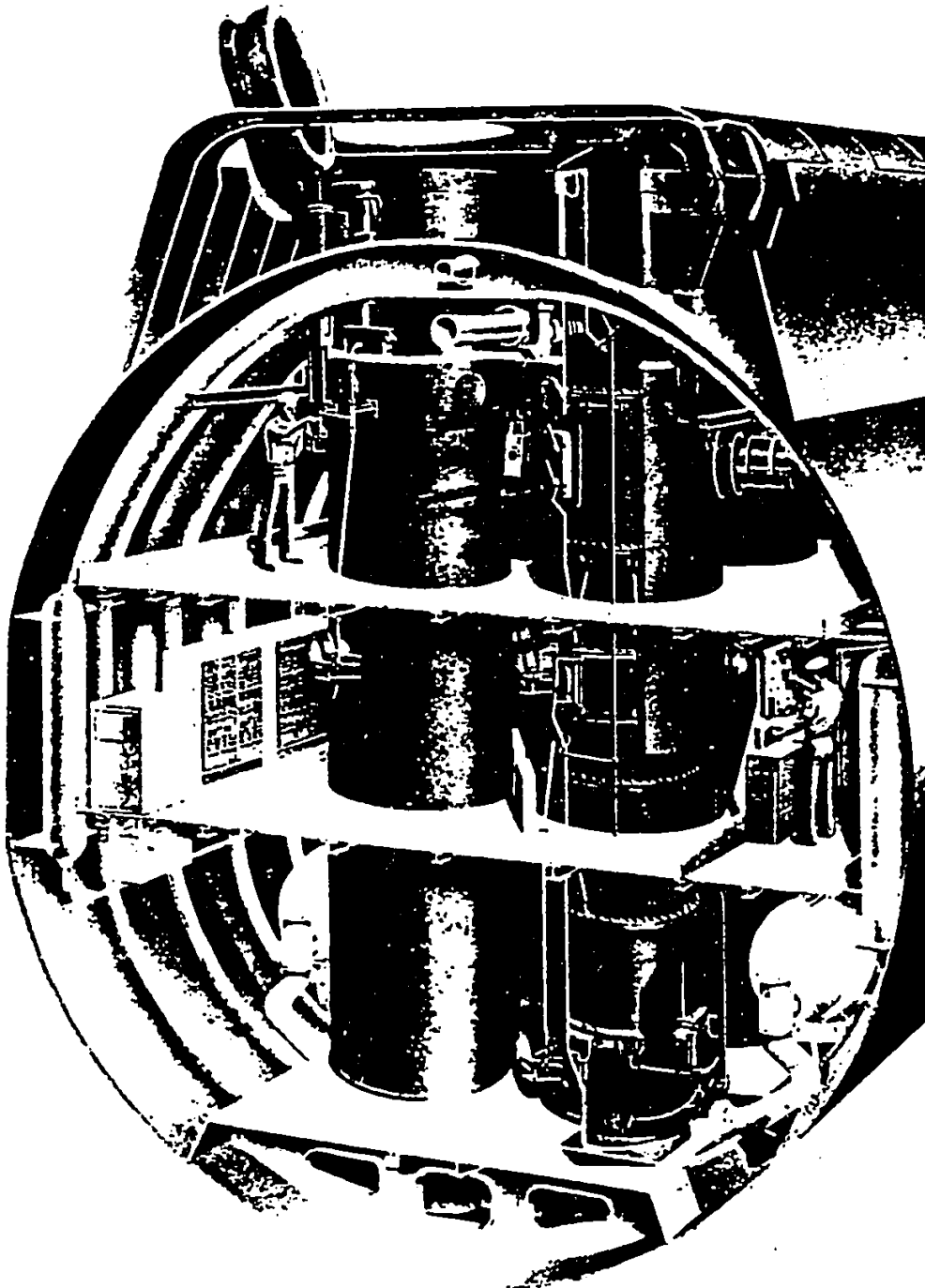

Figure 2

LAUNCHING COMMITTEE DISCUSSION

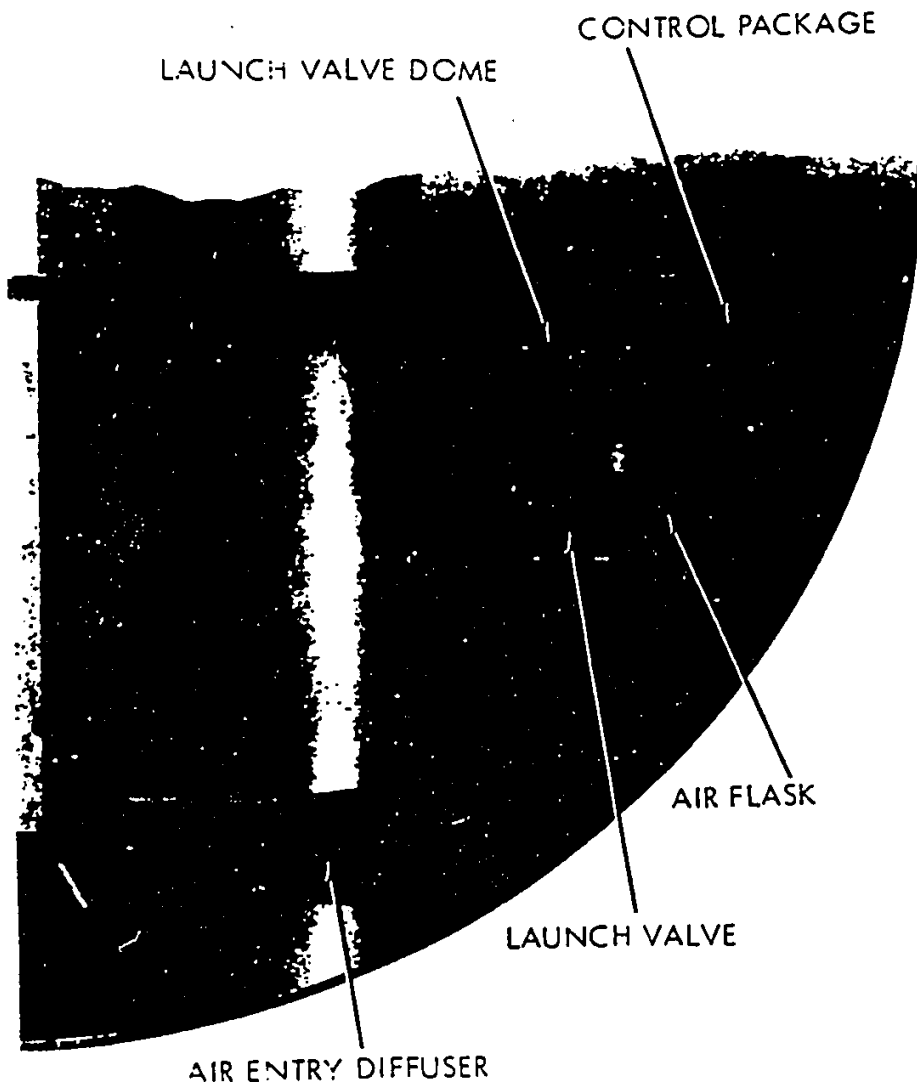

Figure 3

## LAUNCHING COMMITTEE DISCUSSION

"Figure 4 is a cross section of the launch valve now installed on the 598-Class. There are several problems inherent in the valve design: corrosion builds up inside the body of the valve; dirt or debris collecting between the poppet and the seat causes leakage; and the Chevron packing has been found to harden with age causing subsequent leakage past the packing and the piston.

"Early in the program we tried a field fix to counteract the corrosion buildup on the valve body by a brush-type electroplating process known as the Dalic process which consisted of placing indium plating on the valve parts. We tried to do this in the field but we were not very successful. The next step was chromium plating of the inside of the body; the valve now in the 598-Class has a chrome-plated body. The latest design provides a monel and nickel alloy coating which is placed in the valve body by weld deposition.

"Now to prevent the leakage from occurring between the poppet and the seat, we replaced the metal seat with a soft nylon one. Our experience indicates that even with debris or dirt on this seat, the soft nylon still makes an effective seal.

"The launch valve leaks in the 598-Class have been very commonplace. Each submarine replaces at least one launch valve in upkeep and sometimes two, and the major leakage occurs in the areas where the Chevron packing is used as a sealing device. Evidently, the Chevron packing hardens with unexpected rapidity and then loses its flexibility when exposed to high pressure air. The maintenance procedure now used by the tender requires heating those launch valves which have leaking Chevron packing by using a strip heater around the outside of the valve body. The heat is transmitted through the valve, softening the Chevron packing and allowing it to seal. This solution is at best a temporary measure, and each time the flask is depressurized, the valve cools and must be reheated to reseal it.

LAUNCHING COMMITTEE DISCUSSION



Figure 4

## LAUNCHING COMMITTEE DISCUSSION

"While these problems in no way affect the capability of this launch valve to launch a missile successfully, they do require additional effort on the part of the Fleet to maintain launch pressure and prevent too frequent use of the ships' air compressors.

"The version of this valve now provided for the 598-Class is coated with a monel-nickel alloy on the inside of the valve body, the Chevron packing is replaced with O-rings, and the hard metal seat with a soft nylon seat. The Fleet is starting a program to replace the presently installed valves with this newer version.

"Figure 5 shows the eject service package which has had relatively little trouble. We found at the beginning of the patrol that the bushings in these valves start cracking on usage and this was fixed simply by replacement with improved types.

"Associated with this eject service package is the blocking valve which is the final safety interlock in the launch system. We have a few unsatisfactory situations existing with it. Figure 6 shows the details of the blocking valve. Its purpose is to prevent inadvertent firing of the launcher; it admits control air to the launch valve which lifts the poppet on firing. Passage of this control air is stopped by the blocking valve, unless a key lock is unlocked. We have been experiencing two problems; one I think has been pretty well taken care of. The crews learned that you did not need the key to unlock this locking valve, as it could be done with long-nosed pliers or a screwdriver. The other problem was that these parts become sticky and start binding after long idleness in the building yards. As an interim correction for this we wrote a maintenance specification which required that the ship's force periodically manually operate this valve, and lubricate it with graphite as required. We have a new SPALT out which provides a blocking valve which is standard equipment on the later ships. This new valve consists of a locking device which is not susceptible to unlocking by such items as screwdrivers or pliers. The valve is also constructed of better materials that will not become corroded and cause binding.



LAUNCHING COMMITTEE DISCUSSION

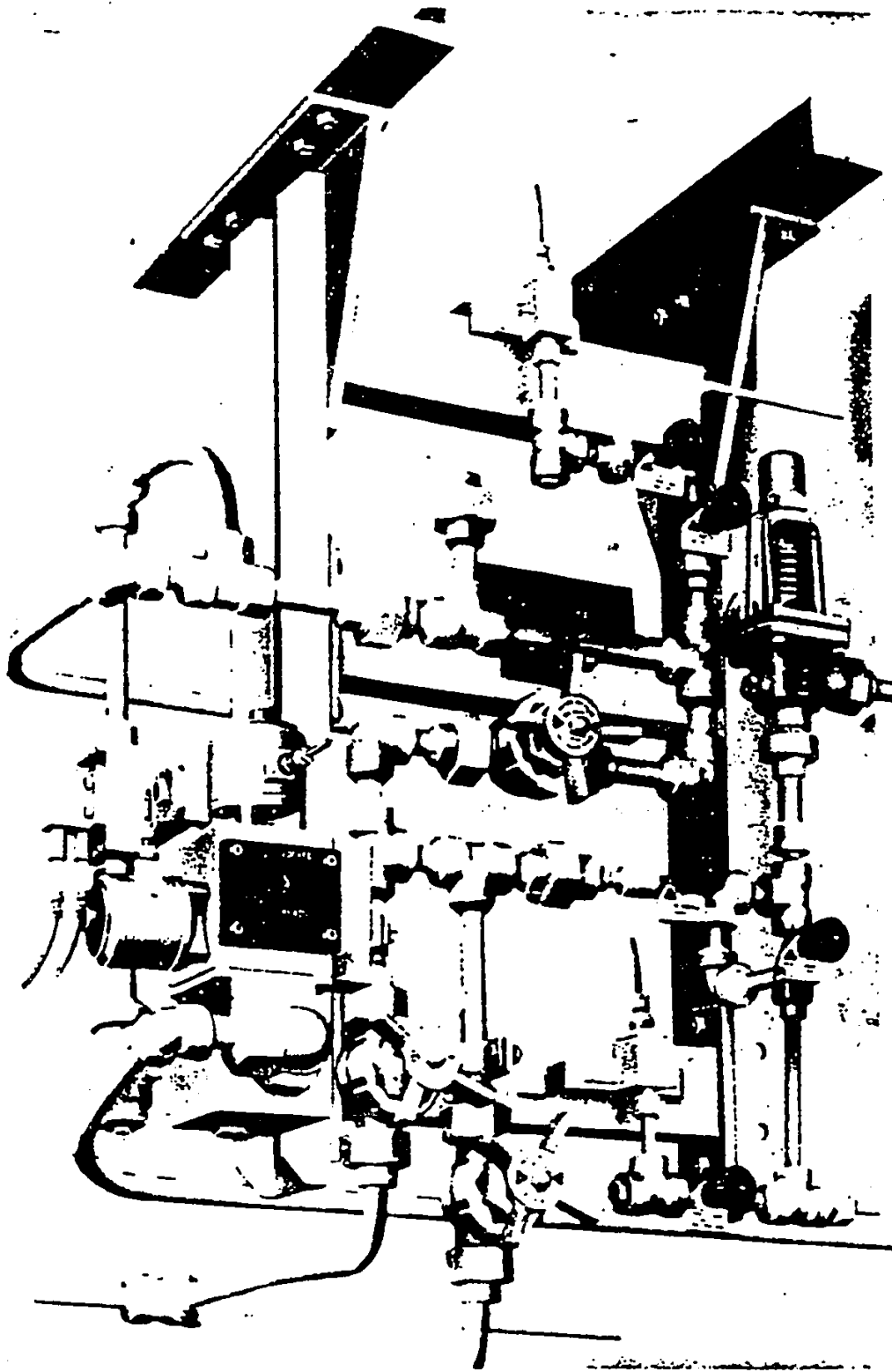

Figure 5

LAUNCHING COMMITTEE DISCUSSION

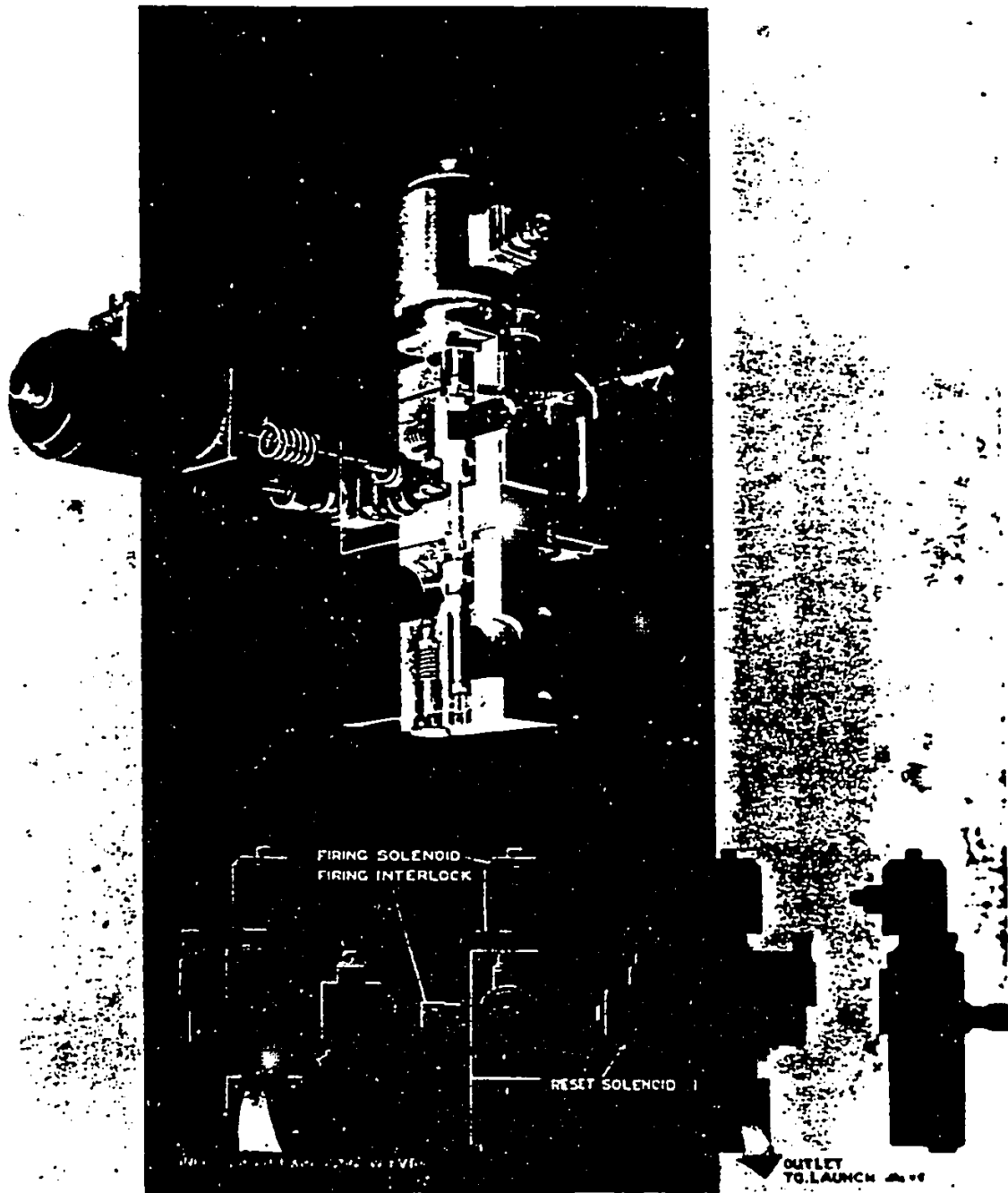

Figure 6

## LAUNCHING COMMITTEE DISCUSSION

"The launch tube shock absorption system on the 598-Class, shown in figure 7, consists of horizontal and vertical liquid springs designed to provide a maximum excursion of about four inches under shock conditions and horizontal and vertical lockout cylinders which harden the tube during launch. The horizontal springs are charged to 20,000 psi and the vertical springs to about 13,000 psi. A leak-rate of 60 psi per week was established for this installation with a pressure check every six months. Springs with a leak-rate greater than 60 psi per week are to be replaced. Using specifications which required holding this pressure for long periods of time with low leakage rate was considered quite unusual, but the selection was based on good technical evidence and test experience. These springs were subjected to a test program to detect early leakage and none was found. However, this testing produced an unjustified complacency with the 608-Class springs which I shall discuss later.

"The upper portion of figure 8 shows the upper seal with its retaining ring and the diaphragm with its adapter mount on this retaining ring. The retaining ring, being made of a ferrous material, is subject to corrosion, and we have found that frequently, when diaphragms are replaced, we must chase down threads and bulb holes. We do not plan to do anything about this at present, but we will watch this situation carefully.

"There has been much discussion about the upper and lower inter-tube seals and the life of the rubber in these seals. The best technical estimate predicts a reliable life of about three years and several of the 598-Class had these seals installed just about three years ago. The lower seal is the more critical of the two, and could abort a launch if it failed. Our experience has shown us that this seal is subjected to chafing. We have come out with a SPALT to replace the lower seals, and to provide a backup ring which is contoured to allow for a more gradual breakaway for the seal and prevent the chafing. The Fleet intends to replace the lower seals each time they do a launch valve

## - LAUNCHING COMMITTEE DISCUSSION

replacement. Because the missile has to be out of the tube to replace the launch valve, we feel that this would be an opportune time to replace this seal.

"A spare set of upper seals -- new seals -- has been provided for the 598-Class. These seals are fitted with a hose connection to do two things: to increase the drain-down time after the area above the diaphragm has been flooded and the hatch closed; and to drain down the seal completely after the upper area is drained, preventing that small amount of water which collects in the bottom of the seal from going back into the pressurization system. I think the Fleet would also like to renew the upper seals when they renew the lower seals and their plan at the moment is to do so.

"The umbilical retract mechanism has been a reliable device with no reportable problems. Upon examination, this equipment appeared to be essentially in the same condition as it was when it left the factory.

"Corrosion of the launch tube itself has not been a serious problem to date, although some small signs of corrosion at the flange of the launch tube section have been noted. An occasional touch up with paint has been sufficient to maintain the tubes in good functional order. Also, the support ring at the bottom of the tube appears to be in good functional order.

"The control panels, the LOP and LPP's, have also been relatively trouble free since deployment, although one crew has questioned the rate of lamp bulb failure on these panels. These failure rates have since been studied in detail; they appear to be consistent with the rated life and have posed no problem.

"We have had occasional failures with some of the small transformer diodes and relays, but the failure rate is low and acceptable. On the whole, the launcher control equipment is holding up quite well.

LAUNCHING COMMITTEE DISCUSSION

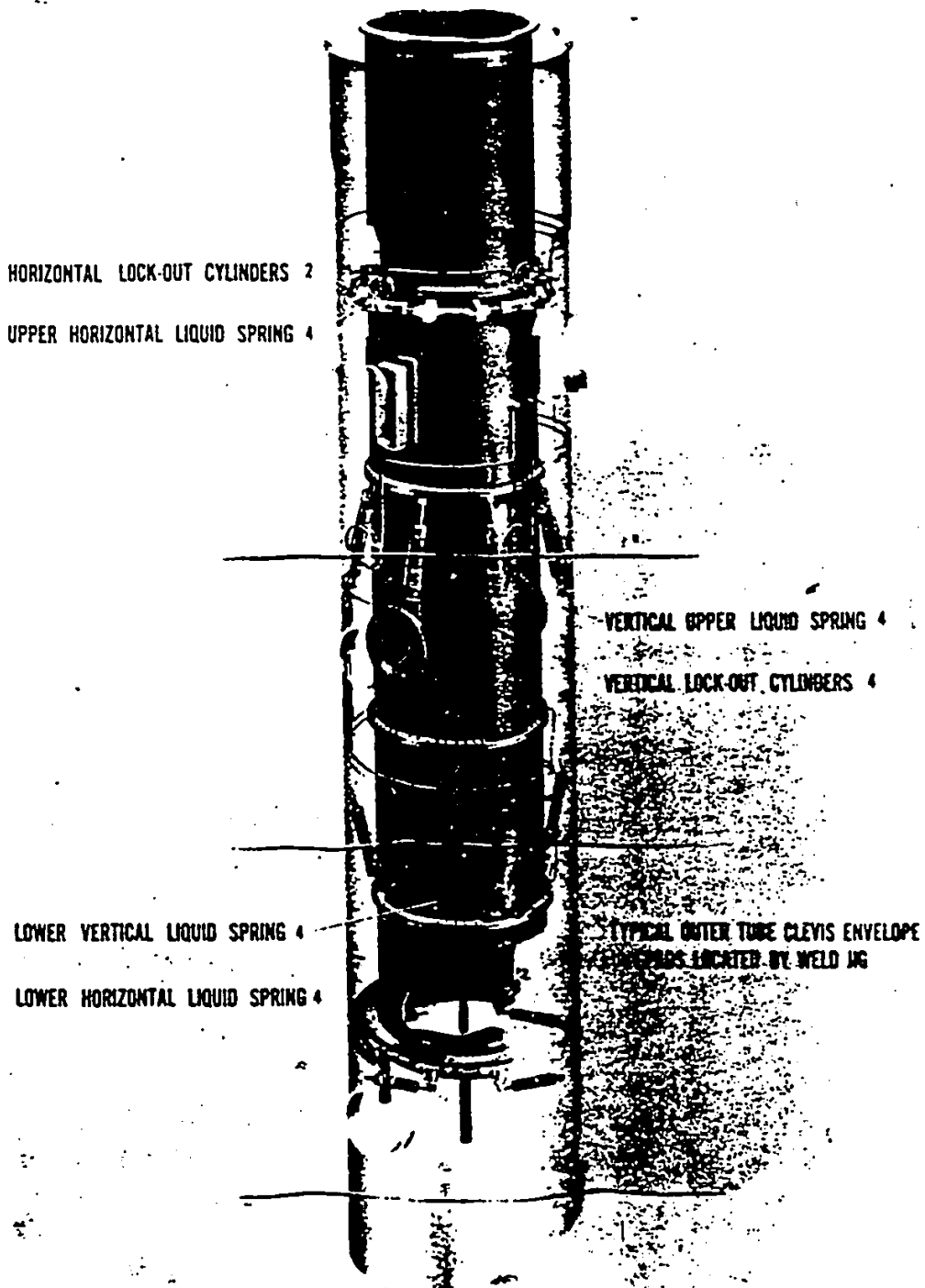
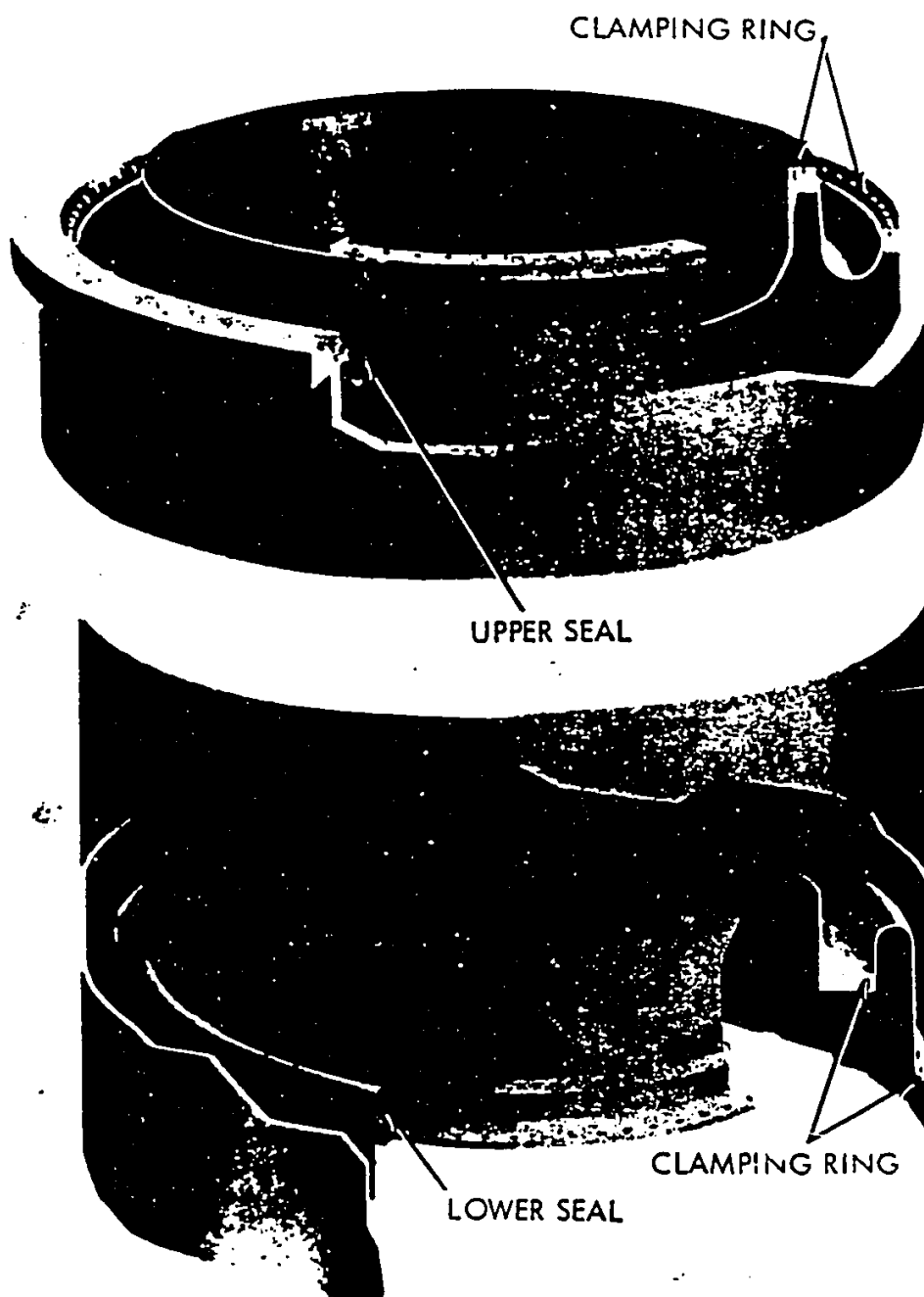

Figure 7



SSBN INTER TUBE SEALS

Figure 8

## LAUNCHING COMMITTEE DISCUSSION

"Figure 9 shows a view of the diaphragm mounted on the launch tube. There is an explosive cord installed in the diaphragm in a phi-shaped pattern and this cord is detonated at missile first motion to cut the diaphragm away so that it does not interfere with the missile coming out of the tube. The cord is initiated by four detonators, and these are operated from the departure switches which are installed on the hold-down clamp ring.

"The chief problem here has been in the improper installation of the detonator squib and pigtails. This problem occurred with alarming frequency on at least one ship. We are coming up with a new design of connector and pigtail which will permit these items to be installed with ease and greater frequency.

"For the 608-Class we really have no significant operational experience. The launch valves on these ships are chrome-plated and the Chevron packing is nylon. They are better valves than those on the 598-Class, but not up to the standard set for the 616-Class. We have a SPALT to replace the Chevron packing with the O-ring seals for the 608-Class. SPALT kits will be available in mid-summer.

"The liquid springs in the 608-Class were first assigned the same leakage criteria as on the 598-Class. After careful examination in the factory of the leaking springs coming back from the 608-Class it was determined that those with chrome-plated stems had microscopic cracking through which the fluid was escaping in minute quantities. These springs now in use are a mixture of chrome and non-chrome stems. The present maintenance practice is to check the charge on each spring periodically, and re-charge those that are below the required pressure. The springs are being replaced in those cases where the leakage exceeds approximately 3000 psi in one patrol, or about 250 psi per week.

"We are not going ahead with a mass replacement, for the springs with the chrome stems are being weeded out only as they fail or show excessive leakage. We are just taking the ones that fail and stripping the chrome.

LAUNCHING COMMITTEE DISCUSSION

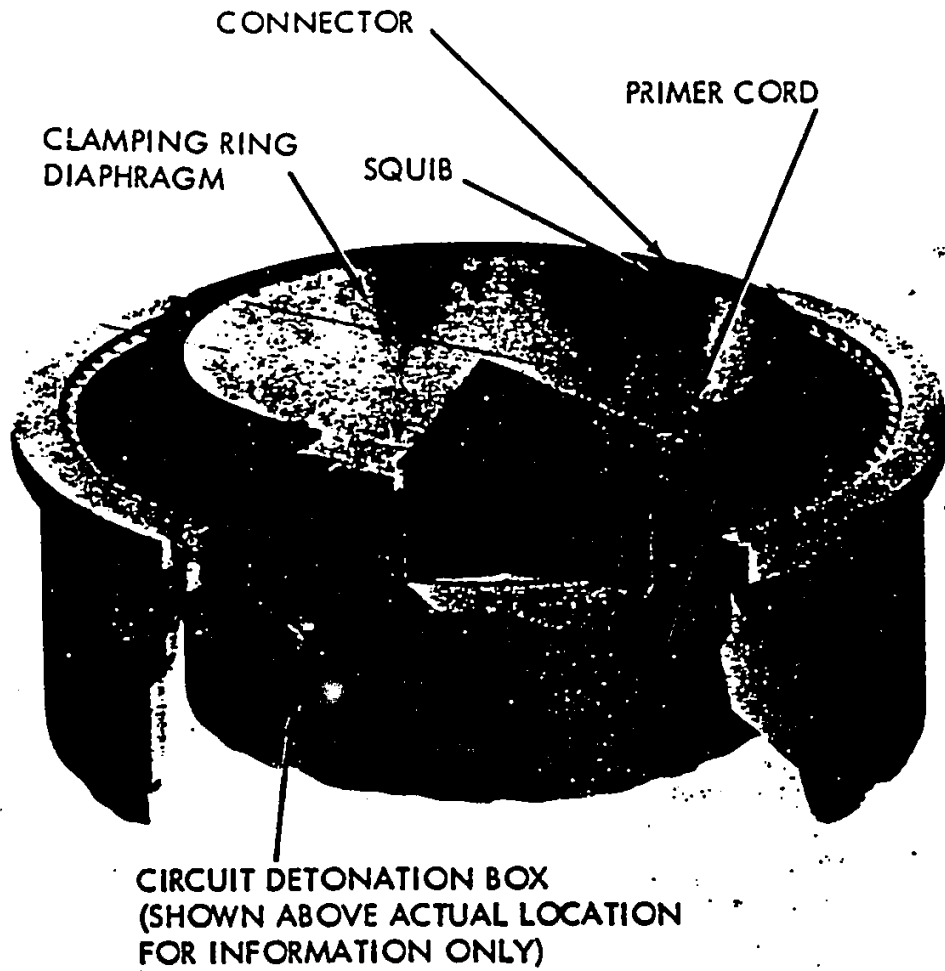

SSBN DIAPHRAGM

Figure 9



## LAUNCHING COMMITTEE DISCUSSION

"In conclusion, the operational readiness of the 598-Class launching system during patrols has been nearly perfect but in some instances it has been done through considerable maintenance effort. We expect that each successive class of ships will contain launch systems that will simplify the maintenance and steadily eliminate most of the problems I have discussed this afternoon."

On questioning, Commander Hammerstone explained that he had not discussed the air and nitrogen systems or the hydraulic operating system because they did not come under the control of SP22 but were ship's systems.

Captain Styer mentioned the squib problem as one that far transcended any of the problems thus far mentioned in terms of launch system reliability. Commander Hammerstone agreed.

"My impression is that the squib problem was basically one of replacement," said Mr. Morton, "and the possibility that the squib and its wiring might deteriorate if water should flood the diaphragm."

"The problem has been one of improper installation," explained Dr. Mechlin, "and we have checked the returned hardware to verify this fact. The squibs have been misoriented in their holders with the result that the explosive charge in the cord can be destroyed without ignition. Having discovered this ability of the operators to get the installation fouled, we are just about to issue an equipment revision to cover the problem."

"The installation error occurs too easily if the operator is not aware of the alignment ears on the connector," added Commander Hammerstone.

"The SSB(N)599 had one casualty not associated with the launchers," continued Dr. Mechlin, "which required that diaphragms be replaced."

## LAUNCHING COMMITTEE DISCUSSION

only a few hours before they sailed. The crew members did the work at night under very poor conditions and the circumstances showed up in the poor quality of the installation."

"You can make an equipment correction based on this experience," observed Captain Styer, "which may handle it in the future. Should we also update the technical manual to point out the pitfall here?"

"I do not think that we can mark this error off to stupidity, but rather to the fact that we did not anticipate all the possible unfavorable conditions that might exist at the same time," replied Dr. Mechlin. "That is a vital area, but it is one that we have been able to fix easily. There is no problem of water affecting either the squibs or the wiring; if the installation is right, the wiring does not even need insulation because the conductivity of sea water is not relevant at the voltages used. Flooding itself is no great problem unless the squibs are mis-oriented because the system will operate if flooding occurs; it only fails when the misorientation takes place. We anticipated everything except the installation problem."

"We can benefit from this experience by changing the technical manual," replied Captain Styer, "to point out the particular hazard."

"I reviewed the technical manual," said Dr. Mechlin, "and it pointed out the problem about aligning the ears quite specifically. It does not have a special caution notice pointing out the consequences and I am not sure that I feel such a notice is required."

"It is helpful to the men doing the work to know about previous failures," argued Captain Styer, "and I think we lose part of the benefit of our mistakes if we do not pass the word along. For example, the SSB(N)599 had some previous experience with flooding problems, but it happened to the other crew and hence no one was aboard who knew about it. If the OP reflected actual experience, or just underlined critical items in red pencil, it might have saved us these failures."

## LAUNCHING COMMITTEE DISCUSSION

"If you start underlining," observed Admiral Smith, "then people never read anything except the underlined sections. Pretty soon you will be underlining the entire book."

"As soon as the casualty occurred," said Commander Hammerstone, "we sent messages to alert the Fleet to the possibility. One specified that the installation must be made according to the OP, while a second message asked all ships to check their installations to be sure they were correctly installed. As yet, we have received no word back about other installations."

In reference to Sabot launchings, Commander Hammerstone explained that the Sabots were ready in Holy Loch, waiting only for the squadron; discussions with the squadron had indicated that possibly four Sabot firings per ship per year could be made, but that the squadron could not handle four Sabot firings per upkeep period.

After a brief general discussion of Sabot launching, Captain Styer stated that there was a real need for information back from the Sabot launchings, and that they should be carefully documented, even as the SDAP and ORRT launchings are.

"My interest here is that we try to find a way to carry out these operations," commented Admiral Smith, "in a way that will provide a maximum amount of exercise for those parts of the system that are not exercised in the regular WSRT tests."

As no further comment was forthcoming, Admiral Smith called a short recess before the next presentation.

## COMMAND COMMUNICATIONS COMMITTEE

### REPORT DISCUSSION

Captain Dudley introduced himself to the STG membership as Captain Fry's replacement.

"I will not spend time on the written report," Captain Dudley began, "except to highlight it and bring you up to date on events which have happened since the report was prepared. As you may have noted, we have revised the panel organization of the committee and we look forward to greater flexibility in operation and greater inputs into Special Projects.

"In particular, we expect to gain more insight into the needs of the Fleet through our Operations Advisory Panel, which will reflect the attitudes of the Type Commanders and CNO. Then, hopefully, when we put something out, it will have been approved in advance. Early in April we expect a Proposed Technical Approach from BuShips and ONR covering the field of secure ship-to-shore communications. Our Ship-to-Shore Panel will review this study on 11-12 April and make recommendations based upon it, providing we receive permission from OPNAV for the panel to look into it. Preliminary indications from Op37 are that permission will be given.

"The Ship-to-Shore Panel will be busy with a review of the Extreme Low Frequency program, PANGLOSS Task 9, which is a program involving 110 miles of transmission line in North Carolina. In April, we are having USNUSL and BuShips summarize the entire program for us; by the end of April we hope to be able to meet with Admiral Smith and decide exactly where the ELF program should be

## COMMAND COMMUNICATIONS COMMITTEE DISCUSSION

"That is the program that rang all the telephones," commented Admiral Smith. "Did you ever get that situation resolved?"

"We have been able to cut down this problem of phone-ringing," replied Captain Dudley, "by reducing the eight-party lines to four-party lines and taking other measures. Originally we had a good number of phones ringing, but with the aid of the local telephone company we have reduced the number, and we also have been careful about the timing of our testing, to minimize both the disturbance and danger to the local population. Otherwise the program is in good shape. Some of our agreements will expire on 1 April and, if we want to continue testing, we shall have to start these negotiations over again.

"In the field of acoustic communications, we have had some changes. Project LOLA was originally scheduled to be an acoustic survey in one area, but about two weeks ago we changed the operating area proposed for the Pacific and we have had to change our Project LOLA plans accordingly to cover the new area. We will now operate off Chichi Jima instead of Iwo Jima, as earlier planned. We are proceeding with Project LOLA in the hope that it will give us more information on acoustics in the Pacific, so we will be able to make some good decisions on it early this summer.

In the field of communication involving satellites, after conferences with CNO and others, our present planning supports an interim system which will involve the present UHF capabilities. We had thought about a fancier system, but this is slightly beyond the present state of the art.

"We hope to have a satellite package configured for our communications by mid 1964. This date may be rather optimistic but we will certainly try to meet it. We have been working with APL and BuWeps on this project and 1964 is about the earliest time that we can get a vehicle for the satellite. It is also the earliest time that APL will be able to put a package together that will give us

## COMMAND COMMUNICATIONS COMMITTEE DISCUSSION

what we want. Because it is really an interim system, we are calling this a feasibility demonstration instead of a final system. However, we are putting the package together so that if it functions properly it will be a completely workable system."

"What will be the difference between the interim and the next system after the interim?" inquired Admiral Smith.

"If the interim works out well," replied Captain Dudley, "we hope soon after to be ready with a complete straight UHF system. However, we hope that the final system will employ these so-called exotic modulation techniques that can assure us of complete transmission security. We have reviewed this problem with OPNAV and right now we do not have the capability. We hope to have that ability in five or six years."

"Will this system require a different antenna?" asked Admiral Smith.

"Yes, it will," answered Mr Justice, "because the fancy modulation techniques will not make up for the disadvantage of the distance. We will have to get a directional antenna on the submarine."

"This sounds a little like 1984," observed Admiral Smith.

"Possibly so," said Captain Dudley. "Getting back to the report, we are supporting the Command Communications Committee's recommendation to push the BEDROCK II as our short-range anti-jam system. The Naval Research Laboratory is conducting some tests requested by the Committee; we will have a report at the next Committee meeting. We are going ahead with this program and are procuring long lead-time items for three prototypes..."

"On the OPNAV side, since the establishment and use of Specific Operational Requirements (SOR's) to spell out our programs, we have been rather successful in getting SOR's to replace the old Development

## COMMAND COMMUNICATIONS COMMITTEE DISCUSSION

Characteristics. However, we have two areas which are not covered by SOR's, and which are, or may become very critical to us in the future. First is our VLF anti-jam requirement. We do not have good data from CNO about their specific requirements. We are working on this, but do not know when we will have the answer. In this particular example, the SOR would give us a better picture of what they want in the way of the data rate. How long will the messages be? How long do they want to take to send a message? We may have a system that will get a message out in 30 minutes or 15 minutes, but if they have a requirement of 5 minutes, we may not have the answer. We have not been able to pin them down on this sort of thing.

"The SOR does not really give us any assurance that a project will be bought after we get it done, but it would certainly help us in our program to have the SOR even though it might change tomorrow."

Admiral Smith wondered why the program needs an SOR spelled out by OPNAV concerning the VLF-anti-jam program.

"Now we are proceeding as well as we can considering the state of the art in such a development," said Captain Dudley, "and the SOR will work miracles. Its greatest value in this context is in terms of trading off requirements -- if they will accept a very slow data rate, we can offer quite a good anti-jam capability. If they do not care too much about the anti-jam perfection, we can offer a faster data rate. In this case, where we have something like a balance between quantities, an SOR would be helpful.

"A second area in which we do not as yet have a CNO requirement is the Extremis program to let an operational commander know that one of his submarines has gone to the bottom. Here again we face a problem of designing something that CNO may not want."

"We have been struggling with this thing for five years," said Admiral Smith. "How close to production are we?"

## COMMAND COMMUNICATIONS COMMITTEE DISCUSSION

"Not only have we been struggling," replied Captain Dudley, "we have also been spending a lot of money. Right now the system is being redesigned as a result of the tests held last fall."

"The system should be in production in Fiscal 1964," added Lt. Commander Watkins, "so we should have systems by summer of 1964. It is planned to put them on the SSB(N)624 for test."

"How close are you to a production contract?" said Admiral Smith.

"We should be ready after the tests this fall, sir," answered Lt. Commander Watkins.

"The system involved," explained Captain Dudley, "is designed to pass a message that a submarine has been lost either by accident, damage, enemy action, or some other catastrophe. The system must be able to function without specific activation from the ship's personnel."

"I think the most useful thing would be a Ship Characteristic Change," observed Admiral Smith.

"We will need that ultimately in any case," replied Captain Kern, "and you can go directly to one if you have a working system."

"The system that we are now testing," said Captain Dudley, "uses three buoys, one located forward, one aft topside, and the third of being launched from a torpedo tube. If the submarine is smashed by one of the buoys will be released to go to the surface, either by enemy action or by an automatic release once the submarine has sunk to a specified depth. The buoy goes to the surface to broadcast a code message to the effect that one submarine is sunk."

"What are these tests you plan?" asked Admiral Smith.



## COMMAND COMMUNICATIONS COMMITTEE DISCUSSION

"We are doing a surface ship test now," replied Lt. Commander Watkins, "in which we have been launching the device and running propagation tests. It is a small buoy, and its antenna is close to the water. We need sea tests in order to test the distance and reception. We are also running more of the shake-rattle-and-roll tests at NEL and there will be further tests at UERD."

"When will you get results from the propagation tests?" asked Admiral Smith.

"Certainly by 1 May," replied Lt. Commander Watkins, "and by that time we should also have the results of the tests of the improvements made after we failed the earlier tests."

"The equipment failed miserably on the test series last fall," added Captain Dudley, "and had to be completely redesigned."

Dr. Hartmann recalled that Aerojet was possibly developing something to accomplish the same in extremis message by use of explosive charges.

Mr. Eyestone suggested that, inasmuch as Communications covers so wide a field of effort and so many devices, it might be very useful for STG members if a complete rundown on the communications programs were presented at a future meeting. Admiral Smith agreed that the idea would be useful. Captain Dudley promised to prepare a report.

With no further comments, Admiral Smith called for the Submarine Design Committee Report.

## SUBMARINE DESIGN COMMITTEE

### REPORT DISCUSSION

"I am pinch hitting for Captain Sonnenshein and Commander Jackson," began Captain Kern, "and find that I am going to discuss one of the problems I recall discussing four years ago as Chairman of the Ship Design Committee, namely, depth control in submarines.

"Since the last STG meeting, the Bureau of Ships has been spending a great deal of its effort and energy on the depth control problem. For purposes of review I would like to go over the facts that were presented to the Steering Task Group at the last meeting, as reported in the CINCLANTFLT message of 23 January; in this message CINCLANTFLT stated that the first winter patrols of the 608-Class provided conclusive evidence of a serious depth control problem. The message emphasized four major points. First, that in a sea state greater than 3, at slow speed and shallow depth, depth control was gravely deficient. Second, this deficiency jeopardizes the ability to continuously maintain the prescribed posture of readiness during patrol. Third, that control at periscope depth is precarious, if not impossible. The upper rudder is exposed and ships have broached. Fourth, that control at launch depth leaves much to be desired.

"The message emphasized that top level attention to this major military deficiency is required immediately. I would like to bring you up to date on the action that the Bureau of Ships has taken since receipt of that message. We felt that we needed a better definition of the problem and more complete details from the operators. For that purpose we requested SUBLANT to call a conference which was held on 29 January.

## SUBMARINE DESIGN COMMITTEE DISCUSSION

"Present at the conference were representatives from CNO, CINCLANTFLT, COMSUBLANT, DEPCOMSUBLANT, BuShips and SupShips Groton and EB Division, the Commanding Officers of the USS ETHAN ALLEN and the USS SAM HOUSTON, the Executive Officer of the USS THOMAS EDISON and the PCO of the USS LAFAYETTE, Pat Hannon who had been Executive Officer of the USS GEORGE WASHINGTON.

"We spent the entire day in a detailed review of the depth control problem, gleaning, sifting, and discussing requirements. I think it was beneficial, and the net result for the Bureau was that we obtained excellent first-hand information on the problem.

"However, as might be expected, we did not get unanimous agreement on all facets of the problem. There were differences among the Commanding Officers as to which phase or particular facet should be emphasized, and I think this is natural. They operated under dissimilar environmental conditions and each of them had a slightly different mode of operating his ship.

"I think I can summarize very briefly, and I hope fairly, the problem as we saw it when we left this conference. First, in the area of depth control at periscope depth, the depth at which the Type 11 or 8B periscope is used, they stated that at a speed of 6 knots and at a sea state of 3 to 5, depth control cannot be maintained with absolute assurance. The incidence of broaching is unacceptably high, and exposure of the top of the sail is estimated to exist 10 to 25 per cent of the time. Once a ship has broached, it is very difficult to submerge again and reorient to get Type 11 sights.

"Depth control at launch depth was a problem in sea states estimated at 3 to 5 because it was difficult to slow from speeds of 6 knots and achieve a level trim, ready-to-launch posture, at zero speed in the required 15 minutes. This occurred primarily

## SUBMARINE DESIGN COMMITTEE DISCUSSION

because in slowing from 6 knots to about 3 knots, the planes became ineffective, and the depth control system, using the depth control tanks, did not become effective until they reached a speed of 1 knot or less. There was a transitional area from 3 knots to 1 knot in which they occasionally lost depth control, and had to speed up and then slow down again.

"Roll of the ship affected this depth control problem at launch depth greatly. The USS THOMAS EDISON, however, had no problem with roll. This ship was different from the others in that it had installed non-roll sensitive instruments giving them the depth sensing readout that feeds into the depth control circuit for the depth control tanks. The tank level indicators in the depth control tank were not roll sensitive. In other words, a pair of depth gauges had been installed on either side of the ship which gave them an average depth; the other ships of the class had only one depth gauge off the center line. As the ship rolled, this one depth gauge gave them erroneous readings of their actual depth, and the system tried to correct for what was a change in depth only due to roll and not a change in depth of the center of the ship.

"Hovering control, once they had achieved this launch depth, was good in all ships and there was little problem reported here in sea states up to 5. There was, however, some problem occasioned by this roll effect and again the SSB(N) 610 reported that they did not have the problem because their instrumentation was different from the other ships.

"Some concern was expressed about the ability to continuously hover during a 16-missile launch in high sea states; I think this stemmed primarily from difficulties encountered during SDAP ripple firings. Apparently, this problem arose perhaps because the system was not peaked up nor properly groomed.

"All ships had the general problem of sail plane banging. This was associated with shallow depth operation, but had been experienced down to depths of 90 feet, at which depth we are not concerned about

## SUBMARINE DESIGN COMMITTEE DISCUSSION

sea states. When this occurred, it was estimated that the sail planes were not actually being exposed to the air. In other words, it was not the wave height that would expose the sail planes at 90 feet depth but we did have the sail planes banging. We had instrumented the USS THOMAS EDISON in order to establish the source of the sail plane banging problem or correlate the various factors that can cause the sail planes to bang.

"This test had failed rather miserably. We were unable to identify the source of the problem, and unable to correlate the various aspects that affect sail plane banging, or could affect sail plane banging. Such aspects would be position of wave trains over the ship, lifting of the stocks in the bearing, hydraulic system pressure shock, tilting of the planes, cavitation of the planes, and resonance of the surrounding structure in the way of the planes. We could not get any correlation from the findings or from the test results.

"All ships reported the problem of upper rudder exposure occurring in high sea states; this loss of control resulted in a down angle trim by the bow and occurred at an angle by the bow of as little as three degrees.

"General comments were made that near-surface operations are required on the average of once a day. This is based on the total patrol experience of the SSB(N) 598 -- they have to get up on the average of once a day during a 60 day patrol. They strongly encouraged further efforts to develop equipment and systems to remove this dependence on the surface. In other words, they want to be able to operate for longer periods submerged, and to avoid the necessity of rising to the surface at least once a day.

"The Type Commanders strongly emphasized that the problem was so serious that positive improvements by over-correction must be ensured, and that the broaching in SSB(N)'s is more serious than in SSN's since the SSB(N) deployment sites can be determined and occurs frequently.

## SUBMARINE DESIGN COMMITTEE DISCUSSION ..

Mr. Eyestone asked if the reasons for coming to the surface had been classified into categories, and Captain Kern replied that the reason was primarily for Type 11 sights. Captain Styer pointed out that the ships did not come to the surface for communication purposes. "Some of the recent 608-Class patrols have not used the VLF buoy at all," he continued. "They have used the floating wire entirely and the USS THOMAS EDISON used it all the way from test depth up to launch depth.

"There is no operational procedure that requires the ships coming up once a day to take a Type 11 sight. Another reason to come up might be to confirm or classify contacts the ship has on his sonars, for example, trawlers.

"Principally, these ships come up to confirm platform rotation results and to keep their azimuth as error-free as possible so that they can squeeze down the CEP."

A discussion followed in which it was noted by Dr. Craven that this was one instance where the SIOP (Single Integrated Operating Targeting) was different from the TDP, and this created a problem because if the SIOP requirement is beyond the TDP specification, it would be much better to know what some of these requirements were in order to design things differently. Admiral Smith stated that it was necessary not only to tell the targeting people what the accuracy was, but also to prove it, and that proving it was becoming very difficult as it was taking more and more data to justify or support the use of the sighted accuracy in targeting.

"We are finding," said Mr. Morton, "that the value of the Type 11 is not so much just adjusting the azimuth or making the azimuth bias correction itself, but in making computations of other problems such as roll, pitch errors in the system and vertical errors in the platform. This is coming from the use of the Type 11 by multiple sights and multiple headings rather than just the one sight."

## SUBMARINE DESIGN COMMITTEE DISCUSSION

correction that the Type 11 was originally assumed to make as a means of correcting headings. This has shown up very dramatically in the last couple of patrols, and this is the benefit of the Type 11."

"You do not have to validate the SIOP data," said Admiral Smith. "You take a small enough number of readings to validate that it is between one and two miles and then use the two-mile data. The only trouble is that this is not satisfactory -- people want to get credit for 1.03 n.m. CEP and then they require the data to justify this figure."

Dr. Craven remarked that the number of missiles required to cover a particular target was smaller in the 1.03 n.m. mode and that from the additional cost-effectiveness standpoint the gain might be worth while if indeed all one has to do is demonstrate 1.03 instead of 2.

"There is no question of a direct solution to this problem of surfacing," said Captain Kern. "The simple approach in BuShips is to avoid the surface, but the SSB(N)'s on patrol need to get to surface and use a periscope once a day."

Another reason for coming to the surface," remarked Commander Slonim, "is that the VLF transmitting stations were down in a tactical situation and backup communications would require a near surface operation."

"That is a good point," said Captain Kern, "because if we decided against going to periscope depth at all to solve the problem, we would be criticized for using, say, LORAN C, with only the floating wire. We operate a redundant navigation system that depends on the Type 11 and the depth sounder, BQN-3, and I think we would be missing a bet not to use the Type 11 as it is designed."

"To summarize the actions that we have initiated since we received that message from CINCLANTFLT, we feel that the best approach to the near surface depth control problem is to build

## SUBMARINE DESIGN COMMITTEE DISCUSSION

a higher sail and increase the height of the mast in order to maintain depth in high sea states. If we put the ship bodily deeper in the water so that it can operate in high sea states, it could take the Type 11 sights from a deeper depth. Essentially, we are talking about doing this to the last 12 submarines."

"What is the practical change in keel depth?" asked Dr. Mechlin.

"At the moment," replied Captain Kern, "we have examined in detail a 10-foot increase in keel depth which would give us a considerable reduction in the Cummings, or suction, force. We also based this 10-foot estimate on past experience, namely, the actual work that was done on the USS GROWLER, an SS(G) type of submarine that had a serious depth control problem similar to the one that has been reported -- in fact probably more serious.

"The sail was heightened ten feet and the USS GROWLER now has satisfactory depth control under near surface conditions. I might read a portion of the USS GROWLER letter on this to PACFLT.

'The recent ten foot extension of the sail has vastly improved depth control, both at periscope and snorkel depth. The ship successfully snorkel charged in state 6 to 7 seas, an impossible feat before modification. Some difficulty maintaining depth is still experienced when heavy seas, primarily long swells, are coming either from ahead or astern.'

"In the THRESHER-Class, where a similar depth control problem exists under near-surface conditions because of the very low sail and short mast, we have put in a higher sail and lengthened the mast to get the ship bodily deeper in the water.

"The problem with this approach is, of course, that it requires extensive change and is not readily backfitted on such ships as the



## SUBMARINE DESIGN COMMITTEE DISCUSSION

608-, 598-, or 616-Classes. We have now started with the Electric Boat Division a detailed design study of raising the sail on the 640-Class. We have not stopped the design work to go ahead with the lower sail, but we have these parallel studies under way to provide a detailed set of plans for a higher sail. We are looking at the weight implications, the naval architecture, and type of stability control implications of the change.

"Actually, three approaches are being examined. One is to increase the mast and sail heights ten feet, and our study shows now that this is feasible; second is to provide a conning tower or pods above the pressure hull that would permit retaining the same mast height, but would raise the mast the additional 10 feet required to get the ship bodily deeper in the water. The third approach is to increase the height of the sail six feet and the height of the mast 10 feet, while swallowing 4 additional feet of mast that would protrude above the sail if there is room below the existing mast to do this. This last approach appears right now to be the most attractive. The conning tower study does not require a new mast design, but the other two that appear more feasible do require a new design of the Type 11 mast. We have asked SP to investigate what is involved in giving an increase of 10 feet in the Type 11 mast."

"You said this design change would start with the 640-Class," said Admiral Smith, "but equipment for the 640-Class was ordered last summer."

"The design change would have to proceed on a high priority basis to get equipment delivered in time for the 640-Class," said Captain Kern. "The times we got were a year and one-half from 'Go' to delivery of an extended length Type 11."

## SUBMARINE DESIGN COMMITTEE DISCUSSION

"I would like to point out," commented Dr. Craven, "that the curve in the Cummings Report shows that an effective 10-foot change results in a reduction of a magnitude of approximately two in the Cummings force for a given sea state, but that factor of two is swallowed up by a change in a 2-foot type of amplitude on the mean sea state. In other words, if you had a 16-foot mean amplitude wave, peak to peak, you would go from 2000 pounds to 1000 pounds by making a 10-foot change; if you went up to 18 feet, you would be back up at 2000 pounds again. So it buys you 2 feet of mean height as far as the sea state is concerned."

"If we are talking about the mid-range of a state 5 sea," replied Captain Kern, "we effectively decrease the suction forces on the hull by a factor of 2. This is correct."

"This does not move you out if you are at the middle of a state 5 sea," continued Dr. Craven. "This moves you to the top of the Sea State 4. If you are at the top or the margin of a Sea State 5, this moves you to the middle of a Sea State 5 -- half a sea state."

"If I understand the limitations of the Type 11," said Dr. Mecklin, "it is frequently used in high sea states at speeds of 3 knots and below -- that in a Sea State 5, you were allowed zero headway. Is this true?"

"No," replied Captain Kern. "The Type 11 is supposed to be usable at speeds up to 6 knots in a Sea State 5, and it is my understanding that the ships are using them at this speed." Mr. Cest noted that the only limitation to this would be the weather.

Captain Kern then returned to the Cummings Report by stating that he believed Dr. Craven had read from the curve for zero speed, and Dr. Craven replied that was so, and that according to Dr. Cummings, the Cummings force itself does not change with

## SUBMARINE DESIGN COMMITTEE DISCUSSION

with ship speed. "There is an effect and you have to compute it constantly, but it does not change materially with ship speed."

"As we understand it," said Captain Kern, "there is some considerable effect in reducing ship speed since the Cummings force is generated primarily by velocities acting over the hull of the submarine. There is a point where these velocities become additive -- the ship's velocities plus the wave velocity -- and inject a considerable increase in the force. I am not prepared, however, to say if this is a factor of 1.5 or 2."

"The problem," said Dr. Craven, "is in saying there is linearization involved, but the forward weight of the ship produces as much Bernoulli effect above as below. Nonetheless, the wave velocity has this exponential variation from the surface down, so it still produces a differential."

"The velocity does increase in a new term," remarked Dr. Mechlin, "and that is as the ship pitches, you have angle of attack effects which get to be fairly important at speeds around six knots. So you are concerned both with the instantaneous value of the pitch angle as well as the magnitude of the Cummings force."

"This leads you to some possibilities for solution," noted Dr. Craven, "because if you can rapidly control the pitch angle of the ship, you can start to adjust the circulation around the ship which results in either mitigating or reducing the angle of attack of the ship, depending on whether you have a good control loop on the stern planes. As you put angle of attack on the ship, you can get a lot of circulation around the ship itself which produces substantial little forces one way or the other."

## SUBMARINE DESIGN COMMITTEE DISCUSSION

"This is a term in stability," remarked Dr. Mechlin. "It is an important term and one of the elements of the control problem is not only to consider the DC terms but that term as well."

"We are looking at time constants for the waves running around ten seconds," said Dr. Craven. "I think we are looking at the time constant on the change of angle of attack of a few seconds."

"The ships have used trim angle as an aid in this problem," said Captain Kern, "and some have been quite successful by ballasting and putting an angle of attack on the ship by the stern."

"Does it help to say that the theoretical checks on the USS GROWLER indicated that we were going to get no substantial gains there?" asked Commander Slonim. "That was in the Pacific and was very successful."

Captain Kern stated that when they were making decisions on the USS GROWLER they understood less about it. "We are just now beginning to publish these reports on the suction force -- Cummings effect. We know much more about it than we did at the time of the USS GROWLER. We knew more about it when we made the decision on the THRESHER-Class, and the USS GROWLER results, in our opinion, are somewhat the proof of the pudding.

---

"We took an unsatisfactory ship and made it satisfactory by adding 10 additional feet. We have the same type of problem here, and we think it would be a good idea to have guaranteed solutions in the shortest times on some of the new ships that are on the design boards. This approach is not applicable to the 608- or 616-Classes except at the first regular overhaul."

## SUBMARINE-DESIGN COMMITTEE DISCUSSION

Admiral Smith asked if they could add 10 feet to all the periscopes other than the Type 11, and Captain Kern answered that there were only four penetrating masts involved in the lengthening, the Type 11, the 8B, 2D and ECM masts.

Captain Kern said that the 2D did not have to be larger because it was taller than the 8B and gave great operating depth now. "It is taller than the Type 11, so in getting the Type 11 depth, the 2D sticks farther out of the water, and it is not very useful because it is not faired. Going at 6 knots it cannot be used because it vibrates too much."

Mr. Cestone felt that it would never work to lengthen the Type 11 mast because of the optics problem involved. "We are looking at other programs such as the use of viticones." Admiral Smith noted that this would require a new program starting nine months behind schedule. Mr. Cestone said that raising the sail and lengthening the mast might indeed require a new program.

"We will have the two designs," continued Captain Kern, "but we are not stopping the design progress to accommodate the present length of the Type 11. We feel that it is most urgent to get on with the tail design. Once we get a date when the Type 11 will be available, the design will be married into the shipbuilding schedule."

Mr. Cestone noted that Sperry and Electric Boat Division were investigating the problem of moving the bearing mounts up in the sail area, and he felt concerned about the problems involved in doing this.

"Before Captain Kern leaves the depth control problem," said Mr. Eyestone, "I wonder if there is a rational possibility of monitoring the azimuth performance with the available bottom data and platform rotation. Compared to the monitoring that you can get in a state 5 sea with the Type 11 periscope, perhaps we already have at least as

## SUBMARINE DESIGN COMMITTEE DISCUSSION

good an ability to know what the system is doing. In other words, you have two ways of monitoring azimuth -- perhaps Type 11 monitoring is unnecessary. I am assuming that there is going to be a deterioration of what you can get from Type 11 monitoring in a state 5 sea for two reasons. One is that the presence of cloud cover obscuring stars must be considerably higher in a state 5 sea. The second reason is that there are more strains put upon the periscope at that time and there is a higher computation process then to resolve through the pitch and roll angles."

"To provide an immediate improvement for the 608- and 616-Classes," resumed Captain Kern, "for the near-surface depth control problem, we have a detailed design study under way at Electric Boat Division which moves the sail planes out of the sail and lowers them by transposing them to the bow of the ship. This means that the planes, the operating cylinders, the ram and its associated gear are put in a capsule up on the bow of the ship, getting them considerably deeper in the water, and at the same time giving a much improved trimming moment for the action of the planes.

"We spent years convincing people that the bow of the ship was not the place for planes because they would interfere with sonar there. We now are coming 180 degrees around, at least on a trial basis. We feel that there is some chance of this working without interfering with sonar, based on our tests of the hindsight sonar pod that was very large and mounted right above the BQR-7 sonar. That gave no interference with the BQR-7 sonar in our various trials of that configuration on the 608-Class.

"The pod that is on the BQR-7, put there for hindsight, is bigger than the pod we will need for mounting the planes on the bow, so we have at least some degree of assurance that we will not have a noise problem with the pod. The next question is will we have a noise problem as far as the planes and action of the planes, and the hydraulic system that

## SUBMARINE DESIGN COMMITTEE DISCUSSION

drives the planes are concerned. What we are proposing here is a trial installation. We are going to use a set of the planes and cylinders from the 616-Class ships, build and mount a pod on the bow of the ship, blank in the holes in the side of the sails where the planes come off, and try it at sea. We can have the plans in four to six weeks but we have no date yet for production of the trial installation; we hope to get to sea with it sometime this summer. If it is feasible, we think we can build a kit that could be installed by a team from the tender and could at least be installed on ships on the way, hopefully, without delaying delivery of those ships.

"Lowering the sail planes bodily in the sail creates an interface problem within the sail, disturbs the mast alignment, and involves considerable delay in ship construction. We could eliminate that part of the problem if the kit does not interfere too much with the sonar suit. Again, we think it is worth a try and we have a detailed design study going at Electric Boat Division to convert the present auxiliary tanks to depth control tanks.

"As you may know, the depth control tanks in the 608-Class are located at center buoyancy. They were put there purposely because they are used at launch depth and we wanted to be able to add and subtract weight without any trimming moment.

"Now we have a slightly different problem. We hope by using the forward auxiliary tanks to get a pair of depth control tanks that will give us weight change plus trimming moment capability. Here again we can design a kit, jury-rig a temporary piping set up, that will enable us to fit this on the 616-Class ship and try it at sea. It will tie into the existing depth control tank sensing system and control system; we are running computer studies at Electric Boat to check the effectiveness of this approach and at the same time make a detail design for the approach. David Taylor Model Basin is being directed to arrange for the instrumentation of the sail planes on the SSB(N) 616.

## SUBMARINE DESIGN COMMITTEE DISCUSSION

If we miss the 618-Class, we will try the next available ship for at-sea tests in a further effort to pinpoint the source of sail plane banging.

"We will use the Electric Boat test results from the USS THOMAS EDISON as the starting point to do a better job of instrumentation and testing to see if we can get some results this time. We also have at Electric Boat a system of pre-loading sail plane bearings which can be installed in a ship also as a trial installation, if we can get 618-Class test results on their sail planes. It is indicated that the problem stems from stock slamming in the bearing. We have this pre-load device that will keep the stock pressed up against the after side of the bearing and prevent it from slopping around. It is an added complication, though."

Dr. Craven asked if the banging were caused by the sail plane coming out of the water. Captain Kern replied that it had not been determined. "It could be as the ship drops because of vertical motion of the water by the plane, that the water is cavitating, causing the bubble formed above the planes to collapse and slam against the upper surface of the planes."

"Is there phenomenological data beyond this?" asked Dr. Mechlin. "For example, can you correlate the loudness of the noise with the depth or the heading of the ship, or anything?"

"The report is here in detail," replied Captain Kern. "It is unfortunate, which is the only way I can describe it. We were unable to correlate any of these pieces of information. On the USS THOMAS EDISON we had microphones mounted on the trunk; we had accelerometers mounted on the side of the sail, on top of the planes, on top of the stock, on top of the bearings. We had pressure transducers mounted around, and when we got a bang in one instance there was no change in the pressure transducer in the hydraulic system, and no apparent change in the accelerometers on the sail planes. Then we got a bang in another instance and there would be a pressure fluctuation in the hydraulic system, but at that point we had some considerable



## SUBMARINE DESIGN COMMITTEE DISCUSSION

depth of water over the planes, as measured by the pressure transducer. This just did not correlate. We could not find the source of the banging."

"You need a water velocity of about 25 knots to get decavitation at that depth," noted Dr. Craven.

Captain Thompson asked if this could be model tested where repeatability was possible, and Captain Kern replied that stock slamming could not be model tested but some hydrodynamic features could be tested this way. "Can you vary your clearances, say, between the bearing and the stock in the model?" asked Captain Thompson. "It is a matter of ten thousandths of clearance, and this is pretty difficult to scale down in the model and then simulate banging," replied Captain Kern.

Captain Kern reiterated that they could determine nothing from the tests in the USS THOMAS EDISON except that the test was inadequate. "We plan to leave the instrumentation on in patrol. We have model tests under way at the David Taylor Model Basin to determine the effect on depth control and other ship characteristics such as blade rate, snap roll and turn, stability and control aspects involved when we heighten the sail, and the keel depth of the ship.

"Comparison tests will be run using the existing 608-Class sail design, the existing 640-Class sail design which is the same height as that of the 608-Class but with lowered sail planes, and the existing 608-Class sail plane height with 5-, 10-, and 15-foot increases in the height of the sail. We will examine depth variations of 55, 65, and 75-foot keel depths.

"Model tests and studies have now been completed relative to the effect of reducing the height of the rudder. We have found that directional stability is still satisfactory after we reduce the height of the rudder by some 30 inches, so it is equivalent to the directional

## SUBMARINE DESIGN COMMITTEE DISCUSSION

stability of the 598-Class. The turning circle is decreased slightly by reducing the height of the upper rudder. We are now examining the cost of incorporating this change to get 30 inches off the top of the rudder.

"We have participated with SP and Westinghouse in study groups to examine the possibility of using ULCER equipment to assist in the depth control problem. We understand that it appears feasible to make the ULCER usable at the 50-foot keel depth vice the 70-foot limit that exists now. It appears reasonable that we could expect to use ULCER as a tool for predicting the suction forces by using the cross deck velocities. This then would be used as an input to a control circuit that would drive the planes and/or depth control tanks. We hope this would give us better use of these control features by actually predicting what the surface suction forces are doing to the ship.

"We do not know when this task is expected to be completed, but I understand it is being handled at high priority within SP.

"On the problem of roll affecting depth control at launch depth, we have already taken action to get Electric Boat to build the kits necessary to install the non-sensitive roll depth-sensing equipment in the ships by the tender. We ought to have all the 608-Class fitted very soon, the same as the 610-Class.

"The Commanding Officers of the ships have requested us to give them some information on how the Cummings or surface suction, forces operate. They want to know the best orientation of ship and the optimum operating conditions in order to improve their ability to maintain depth at near-surface conditions. We will have a report ready for them within the next two weeks."

"Apropos of that orientation," said Dr. Craven, "the curve you have on the Cummings Report shows that for beam seas the suction force is very much lower than it is for head and following seas."

## SUBMARINE DESIGN COMMITTEE DISCUSSION

"We have also asked the Type Commanders to give us a report on where and when they have encountered high sea states on past patrols," said Captain Kern. "We intend to use this information by asking the Hydrographic Office for a hindcast of the sea state in full at the time the Commanding Officers were reporting the problem. Since the Type Commanders readily admit that this is a matter of looking at the ULCER and eyeballing the sea through the periscope, they feel this is not a very accurate determination. So we would like to find out if we are dealing with a state 5 sea, or a 6 or 7 sea, on the occasion that gave the problem. The Hydrographic Office has been contacted and has agreed that this can be done fairly accurately and they will accommodate us when we get the information from the Type Commanders.

"We are attempting to optimize the near-surface depth keeping ability of the automatic maneuvering control system that is already installed in these submarines. They have a maneuvering control system that is automatic, in that it reads depth error and has an input to the plane control circuit that directs the planes to keep the ship within  $\pm 6.0$  inches of depth. It works well away from the surface and the surface effects; it has not worked well near the surface.

"Sperry is studying this system and advising the Type Commanders of the various factors that affect the ship at near-surface conditions. The Commanding Officers are attempting to optimize their automatic maneuvering patrol system to do a better job at the near-surface condition."

"What limits are there on the rate of movement of the sail planes?" asked Admiral Smith.

"It is between 4 and 5 degrees per second," said Captain Kern. "At Sperry they designed for this, and you do not know what you have until you get out there and test it. It has come out as high as 7 degrees. I do not recall the exact numbers from these ships. I think it would be nearly correct in saying 5 degrees per second.

## SUBMARINE DESIGN COMMITTEE DISCUSSION

"Over the past couple of years the Bureau has been looking at the hover jet approach. The Model Basin has studied this and has indicated that it showed some promise. Unfortunately, practically all the studies that we have run in the Bureau or at the Model Basin are aimed at using the hover jet at the launch depth condition rather than the near-surface condition. We have one set of hover jet equipment that is on procurement and is scheduled to be delivered in 1964 for test at the Engineering Experiment Station. I think if this works out in test, we can get it to sea and test it in a submarine.

"One of the problems at the moment with the use of the hover jet system is that it has four jets with 2000 pounds of thrust per jet. There is a total availability of about 8000 pounds of thrust which is sufficient for the launch depth control problem. It would be perhaps minimal for the near-surface problem, and we have not run any computer studies as to the effect of speed on this hover jet system when it is in operation at ship's speed. So we have to get some computer studies that will investigate the hover jet system on the 608-Class at, say, 6 knots."

"I might comment here," said Dr. Craven, "that one of the things we are concerned about is not overcoming the entire suction force with the hover jet, because there is a mean suction force that goes with the sea state. What we are concerned about is the rapid fluctuations with the hover jet system so the hover jet in combination with the ballast system can provide large mean forces with a very substantial 8000 pounds. Eight thousand pounds, for example, would take care of the entire mean force we can expect at a 60-foot keel depth in the lower side of a state 5 sea."

"The only point I was making is that the fast response time of the hover jet coupled in a loop with the ballast tank, together with a measure of the loop in which the Cummings force is measured, certainly shows promise of resolving this problem.

## SUBMARINE DESIGN COMMITTEE DISCUSSION

"Vitro has completed some studies of hovering not at near surface, indicating that the use of hover jets can well exceed the present hovering requirements if a combination of the hover jet and ballast tanks is used."

Captain Kern stated that the depth control tanks were adequate at depth, but Dr. Craven said the hover jet exceeded the requirement at depth. "The other comment I would like to make," continued Dr. Craven, "is that I think the 1964 time scale on the hover jets is not as short a time scale as one could bet for a hover jet system."

Captain Styer asked if the hover jet system were feasible as far as space and weight limitations were concerned for the periscope depth. "You have limitations in thrust on the hover jet because of the size of the pump, propeller, motor, and ducting inside the ballast tanks. Without completely redesigning our ballast tank area to take a much larger unit, we are limited to 2000 pounds thrust per jet. However, if you are going into a new design and orienting your tankage around the use of a hover jet, you could probably go to a much higher thrust."

"We have considered only two systems inside the tanks. One is four ducts with individual motors and propellers in each duct. They penetrate from top to bottom of the ballast tanks, port and starboard, forward and aft. The other system uses a single motor and propeller, and the four ducts are openings -- port and starboard, forward and aft. This system uses a means of diverting the flow by hydraulic valving to keep it running all the time. At neutral it puts as much water out at the top as it does at the bottom. When you want to get a thrust action of one direction or another, you can divert the flow to the bottom jets or the upper jets."

"Are we doing any cross comparison studies between this installation vis-a-vis the extension of the sail and other proposed solutions?" asked Dr. Craven.

## SUBMARINE DESIGN COMMITTEE DISCUSSION

"We do not have costs on the extension of the sails yet, and it will be some time before we can get them," answered Captain Kern.

"The question was raised about the possibility of hover jet installation in the 598-Class during retrofit. The 598-Class retrofit includes, for reasons of depth control improvements, a set of ballast control tanks equal in capacity to the 608-Class ballast or depth control tanks with the same control system for these depth control tanks. Since the 598-Class is a smaller ship, we would expect equal or better depth control at launch depth in the 598-Class after this modification.

"This improvement can be accommodated as far as space and weight are concerned in the 598-Class retrofit. It may be possible to get the hover jet as a contender to the depth control tanks. However, it would be risky because this hardware is not tested and developed and the lead time for procuring it would put us very close to the stop date of the 598-Class overhaul. The problem is whether we would have tested the system such as this at sea, and whether we would want to commit the ship to go out without the depth control tanks, expecting that the hover jet was going to work out since the depth control tank system is a proven system at this point."

"Was it observed that there was any difference in the performance of the automatic depth control aboard the submarine which apparently had depth sensors which are insensitive to roll?" asked Mr. Lockwood.

"I cannot answer that," said Captain Kern. "I do not recall that the information was furnished."

"The ships that claimed the greatest problem were those that did not have the new sensors," remarked Commander Slonim. "In other words, the SSB(N)610 claimed the least near-surface problem of all."

"That is sensitized into the automatic maneuvering control system," said Captain Kern. "The sensor does them absolutely no good since they were controlling the ship in manual during the near-surface phase."

## SUBMARINE DESIGN COMMITTEE DISCUSSION

The report was that they did not find any ability to control the ship with the automatic maneuvering control system. I do not know how the new sensors would help in this situation. They might get a better readout on the depth gauge."

Admiral Smith stated that he now accepted Captain Kern's opening comment that BuShips and submariners had spent their full time on this problem. He then adjourned the conference at 5:10 p.m.

NAVIGATION COMMITTEE  
REPORT DISCUSSION

"I am going to talk this morning briefly," began Captain Gooding, "about the recent sea evaluations of the ESG monitor and the status of the Mark 2 Mod 0 as well as the Mark 2 Mod 2 SINS, and the Type 11 periscope. I am also going to speak of some empirical confirmations of theoretical work on the TRANSIT satellite.

"We have had the ESG at sea for two cruises and have received very few fix data on it. We can only say that it ran all the time, and as far as we can tell the lack of fix data is not the fault of the ESG but of the peripheral equipment.

"For example, on the first cruise, lack of a program for NAVDAC and the Packard Bell 250 prevented complete closing of the loop. On the second cruise we had trouble with the PB 250 and we flew a factory man into San Juan to fix it there. So the ESG worked well enough to uncover many other problems on the second half of the last cruise.

"We had problems in the tally punch, in the NAVDAC, and in the MSR's. The ESG was up 100 per cent of the time and we had enough data on the second half of the cruise to make a rough reset. There was considerable noise originating in the interface; the noise pattern is depicted in figure 1. During the current in-port period we got some good calibration data which we will use during the next at-sea period.

"One of the larger uncertainties in the accuracy of a position fix from TRANSIT is ship's velocity. The System Manager did a theoretical analysis which we tried to confirm empirically by putting velocity error into the computer on the USS COMPASS ISLAND with results as shown in figure 2.



NAVIGATION COMMITTEE DISCUSSION

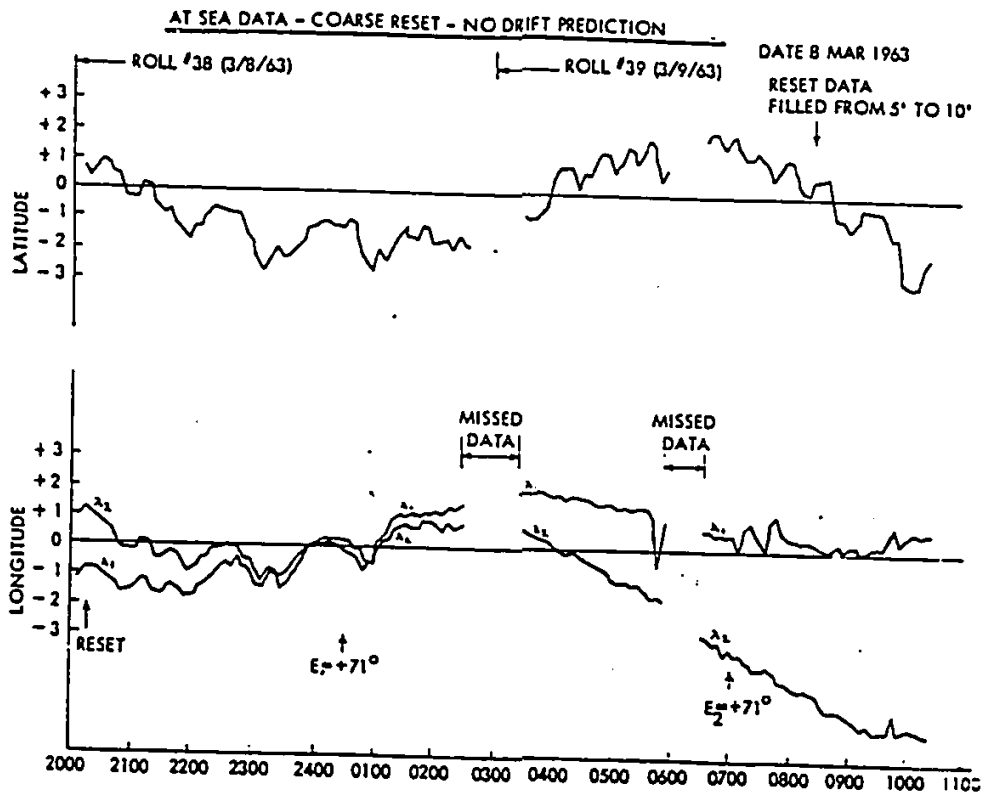

"With cross-track velocity error induced into track position, the average error was 108 feet per knot over five track computer runs; the theoretical value is 102 feet per knot which checks out pretty well. The average one-knot effect of in-track velocity errors and cross-track position errors is 1420 feet. The theoretical value is 1320 feet, better than 10 per cent check.

"There are reasons for the discrepancies. The Material Laboratory assumes that there was a zero velocity error in the original good pass and this, of course, may itself be in error by 0.5 knot. On the other hand, Sperry used an idealized linear model of the satellite orbit; so that there should be some disagreement between these values, as there is. In general, however, the correlation is quite good.

NAVIGATION COMMITTEE DISCUSSION

RESULTS

THUS FAR WE HAVE COMPLETED 5 COMPUTATIONS ON PASS 6, DAY 183, ELEVATION APPROXIMATELY  $57^{\circ}$ . THE RESULTS OF THESE TESTS ARE PRESENTED BELOW.

- A. IN-TRACK VELOCITY ERROR INDUCES NO SIGNIFICANT IN-TRACK POSIT ERROR.
- B. CROSS-TRACK VELOCITY ERROR INDUCES NO SIGNIFICANT CROSS-TRACK POSIT ERROR.
- C. THIS TABLE PRESENTS EFFECTS OF CROSS-TRACK VELOCITY ERROR ON IN-TRACK POSIT ERROR.

RUN	CROSS-TRACK VELOCITY ERROR KNOTS	INDUCED IN-TRACK POSIT ERROR FEET
1	0.70	80
2	1.39	152
3	2.77	312
4	5.55	569
5	8.30	850

THE AVERAGE INDUCED IN-TRACK POSIT ERROR CAUSED BY ONE KNOT CROSS-TRACK VELOCITY ERROR IS 108 FEET. THE SPERRY THEORETICAL ERROR FOR THE ABOVE CONDITIONS IS 102 FEET PER KNOT OF VELOCITY ERROR.

- D. THIS TABLE PRESENTS THE RELATIONSHIP OF IN-TRACK VELOCITY ERROR TO INDUCED CROSS-TRACK POSIT ERRORS.

RUN	IN-TRACK VELOCITY ERRORS KNOTS	INDUCED CROSS-TRACK POSIT ERRORS FEET
1	.12	179
2	.24	348
3	.49	689
4	.96	1324
5	1.44	1990

THE AVERAGE INDUCED CROSS-TRACK POSIT ERROR CAUSED BY ONE KNOT OF IN-TRACK VELOCITY ERROR IS 1420 FEET. THE SPERRY THEORETICAL VALUE FOR THE ABOVE POSITION IS 1320 FEET PER KNOT OF VELOCITY ERROR.

Figure 2

NAVIGATION COMMITTEE DISCUSSION

"The performance of the Mark 2 Mod 0 SINS during the recent USS COMPASS ISLAND run was remarkably good. This is the first production model we had on the USS COMPASS ISLAND, and it is the unit they had in the Material Laboratory for the qualification test. Figure 3 shows the results of that test.

"I would like to remark that this is a Red Book (Technical Development Plan) SINS. The runs marked 'Corrected Values' are the results with a paper reset, and the average error for latitude is 0.2 n.m. and for longitude 0.35 n.m. These runs, labelled 'A' on the figure, are at sea. The others are dock side in San Juan where we got 0.15 and 0.10 n.m. error; after leaving San Juan two runs averaged 0.25 and 0.4 n.m. error. The numbers on the right-hand side of the figure are encouragingly better than the TDP-2500 specification.

MK 2 MOD 0 SINS #20 8 HR F.O.M.S. TP 3-63										
CORRECTED VALUES										
		1ST	8	2ND	8	3RD	8	4TH	8	
RUN		L	λ	L	λ	L	λ	L	λ	AV
C3	A	0.3	1.2	0.1	0.2	0.2	0.2			LAT. 0.2
C4	A	0.5	0.6	0.1	0.6	0.1	0.1			
C5	A	0.1	0.7	0.5	0.2	0.1	0.1	0.4	0.4	LON 0.35
C6	A	0.2	0.1	0.1	0.1					LAT 0.15
C7	D	0.3	0.1	0.1	0.1					
C8	D	0.1	0.1	0.2	0.2	0.1	0.1			LON 0.10
C9	D	0.1	0.05							LAT 0.25
C11	A	0.3	0.6							
C12	A	0.2	0.2							LON 0.4

Figure 3

## NAVIGATION COMMITTEE DISCUSSION

"We have received four Mark 2 Mod 2 SINS -- one went to the Shore Navigation Center in Syosset, one to Dam Neck, one to the USS COMPASS ISLAND, and one to the 627-Class which will be delivered next week.

"North American has had some trouble with this SINS partly because of the very rigorous Factory Acceptance Test and partly because of some equipment troubles.

"Figure 4 is the first 15-hour run of a production SINS. I should perhaps say that you can pass these SINS in one run if you meet certain numbers. If it takes two runs, you meet a less rigorous number; and if it takes three runs, you meet even less rigorous numbers.

"I have the two-run specification which shows 0.63 latitude error, 0.70 longitude error, and 27 arc seconds heading. The 15-hour errors for this run in specification and latitude are not quite good enough for the one-run numbers, so there was a second 15-hour run, shown in figure 5.

"As you can see, after the reset, this SINS was going very well indeed until at 27.5 hours, when they were rotating the binnacle, a cable opened up in the bundle going to the SINS, which was a catastrophe. We waived the last 2.5 hours of this run and we had a 0.30 n.m. error in latitude and 0.52 n.m. in longitude, as well as 14 seconds arc in heading. The velocities are all well within specification.

"Figure 6 is the first 15-hour run of a production system and it is 50 per cent over specification in latitude. Longitude and heading are well within specification. On the second 15-hour run -- figure 7 -- latitude is very good and came over the specification only 5 per cent; longitude and heading are very well within specification. We accepted this SINS and it is the one which is at Dam Neck.

# NAVIGATION COMMITTEE DISCUSSION

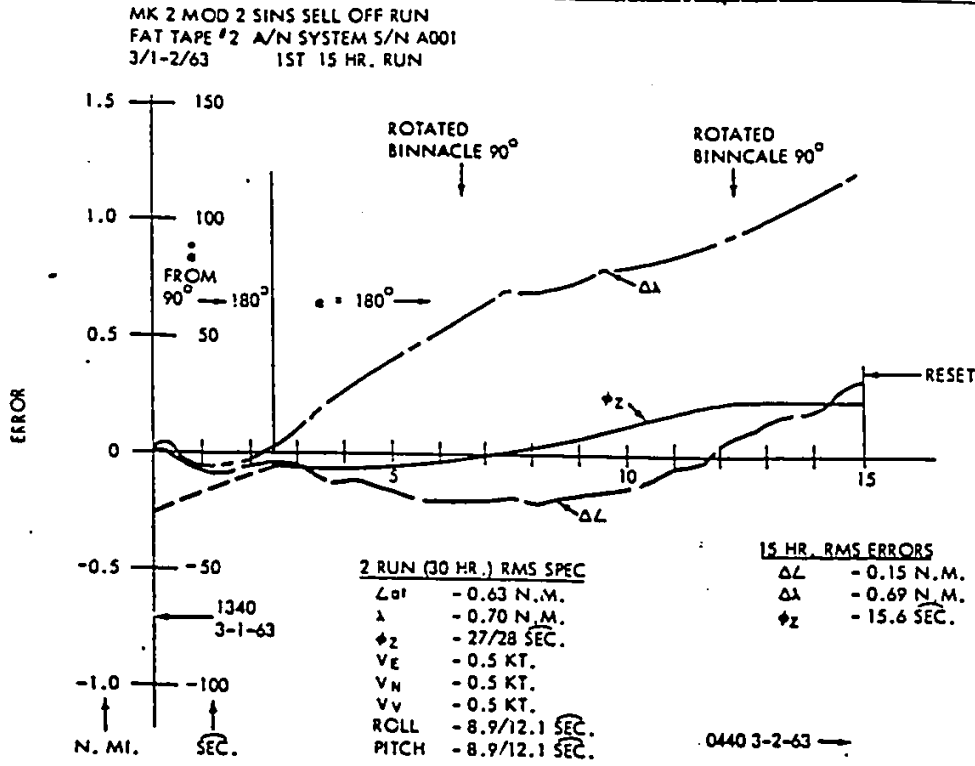

Figure 4

"The fourth SINS was doing very well until about 24.5 hours when Southern California had its first thunderstorm since the blizzard of '55, and they lost all their power!

"I understand that the STG evinced a great deal of interest in a second-generation Type 11 Periscope yesterday for reasons which apparently have very little to do with navigation, but it seems worthwhile to say a few words on the subject.

## NAVIGATION COMMITTEE DISCUSSION

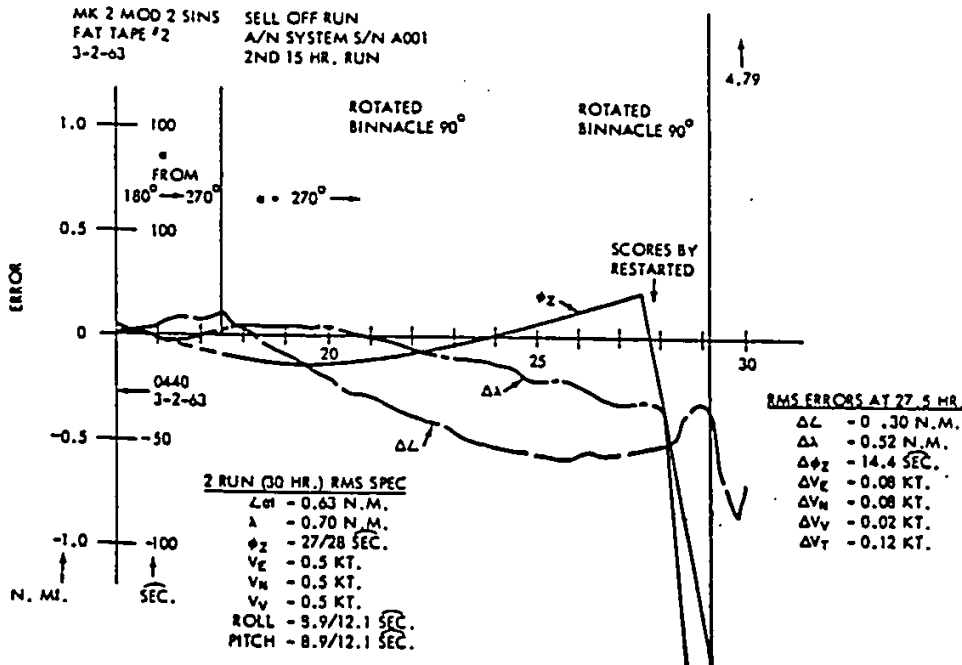

Figure 5

"You may have the impression that SP24 anticipated this depth-keeping and sail-banging problem, but this is not so. We have been looking at a new periscope for some months for a number of reasons. The current Type 11, which is a very remarkable development, nevertheless has some disadvantages. It is expensive, tricky to install, requires the use of a stabilization data computer, which is not very reliable, and most important, it is possible to look downstream to the 640-Class and see that the Type 11 is eventually going to be of very little use to the navigation system. It will not be able, for example, to reset the SINS to the accuracy the SINS itself is capable of holding. I would say that in a modern SINS, with an integral monitor, the Type 11 Periscope's chief function will be to increase the Commanding Officer's sense of security.

# NAVIGATION COMMITTEE DISCUSSION

MK MOD 2 SINS SELL OFF RUN  
 FAT TAPE #2 A/N SYSTEM SER. NO. A004  
 2-28-63 1ST 15 HR. RUN

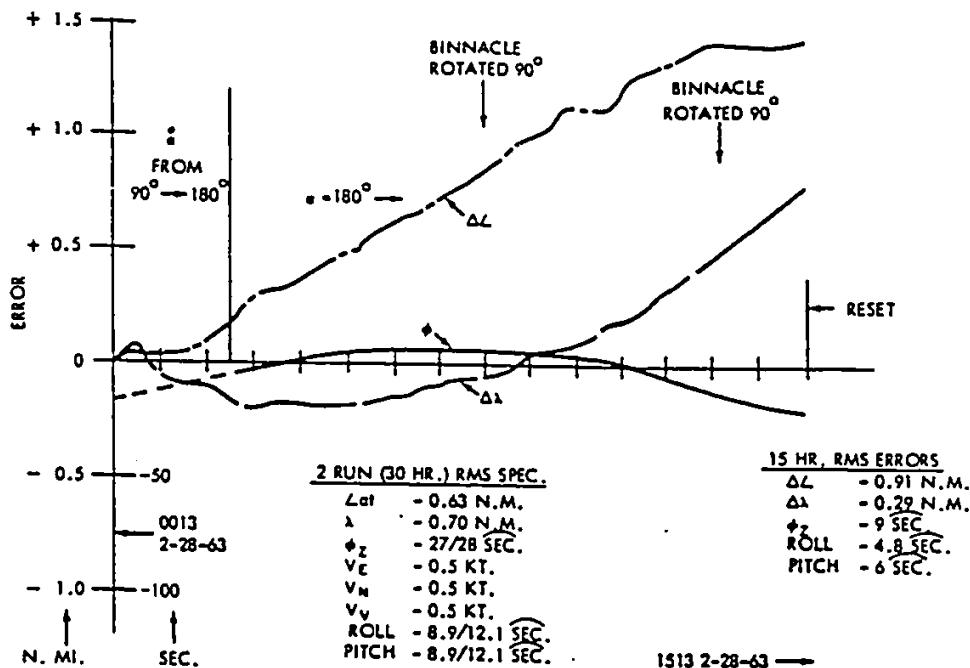

Figure 6

"Some months ago Texas Instruments came up with a proposal for a new periscope and caught us at the psychological moment. We are also considering proposals from Nortronics and Kollmorgen. The requirements we set were high, but we wanted a periscope that was cheaper, more accurate, more reliable, and physically interchangeable with the Type 11 to reduce the installation problems, and also one that was capable of being lengthened. I must point out, in all honesty, that this last capability was an afterthought.

"We have received a proposal from Nortronics which, on a cursory look, may meet all these requirements. We will receive a proposal next week from Kollmorgen. These will all be analyzed by the System Manager, and I would expect not to be able to make a decision or recommendation on this for about two months unless there is extreme urgency. It will take that long to make a sound decision."

NAVIGATION COMMITTEE DISCUSSION

Mk 2 MOD 2 SINS SELL OFF RUN  
 FAT TAPE #2 A/N SYSTEM S/N A004  
 2-28-63 & 3-1-63 2nd 15 Hr. Run

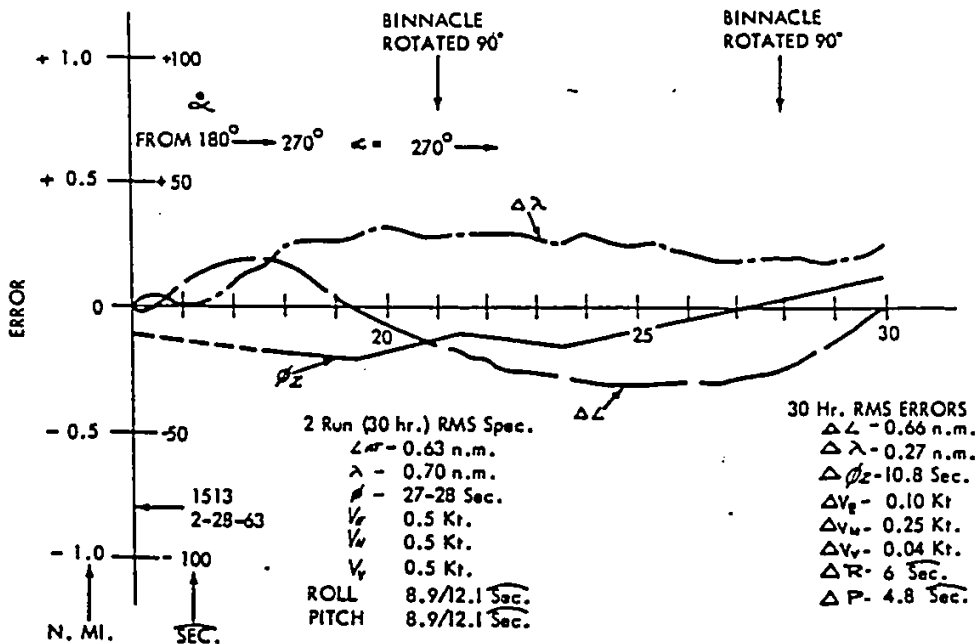

Figure 7

"Do you really believe that you can deliver such a new development for the first of the 1963 construction-use submarines?" asked Admiral Smith. "The rest of the equipment was ordered last summer."

"Yes," replied Captain Gooding. "I would guess that this periscope could be delivered in 14 months from 'Go'. The various contractors involved say 12 months, but I think 14 months is more accurate. I do not know offhand the dates of the 640-Class, but about 14 months from 'Go', i. e., roughly 16 months from now, a new periscope could be delivered. A lot will depend on how much the new periscope is pushing the state of the art. One of the things that is of interest to us is how much current state of the art is in the present proposals. If it requires a large development program, then my confidence in delivering a periscope in 14 months decreases. If, however, available optics and electronics are used, then the timing is pretty accurate."



## NAVIGATION COMMITTEE DISCUSSION

"Is this a case where you deliver the first periscope in 14 months and the next one month later, and the next after that one month later?" asked Captain Sanger. "And do you also deliver the spares that go along with the tactical unit?"

"One of the proposals we have is to deliver the first one in 12 months and then have a buildup to two or three a month," replied Captain Gooding.

"It is of interest that all these proposals would involve replacing the human eye with some form of cathode ray tube."

Captain Kern wanted to know if it were planned to pursue lengthening of the Type 11, and Captain Gooding replied that the current Type 11 could not be lengthened enough to do much good. "You might squeeze a couple of feet out of it, but I think if you tried to push it more than two feet at the maximum, you would have to go to a new periscope. One of the requirements I laid on was that this thing be capable of being replaced at the tender -- in other words, physically interchangeable with the Type 11.

"One of the proposals contains such a process. They checked it out with a former Repair Officer on the USS PROTEUS who feels that it can be done in three weeks. In general, the notion is that you make the outer tube a structural member which need only be coarse trained, and you can take care of your fine training and elevation in the head. This does away with these complicated hydraulics we have in the free-floating periscope. You can use a dry bearing and move it around with an ordinary motor. You could also make the outer periscope more robust so that it could be lengthened. Obviously, we are considering the lengthening as part of our analysis."

"If you lengthen it," said Captain Sanger, "will it still be at the same height when housed? In other words, can you increase the up and down motion as well as lengthening it?"

## NAVIGATION COMMITTEE DISCUSSION

"It depends on how it is lengthened," answered Captain Gooding. "If you increase the height of the sail, you need not move the observer station. If you simply stick the periscope farther out of the water, you have to raise the observer station but if the observer station is no longer a man, but a mirror or a pair of wires, it is not particularly important where it is. If you lengthen the tube and try to house the periscope it might go out through the keel."

"We can take four feet more length and still house the periscope and still not go outside the keel," observed Captain Kern.

"Is the Mark 2 Mod 2 you spoke of previously different from the other one we have had?" asked Admiral Smith.

"Yes, sir," replied Captain Gooding. "The one we had before was an XN model. This is a production SINS, now on the USS COMPASS ISLAND. The previous one was, in effect, a house model."

A discussion followed in which Admiral Smith asked if the SINS was identical with the one on the 616-Class. Captain Gooding stated that it was, and added that the Mark 2 Mod 0 on the 616-Class is being SPALTed with Block 1 changes. "The Block 1 changes are a series of SPALT's to give more reliability and some improvement of accuracy. The Mark 2 Mod 0 on the USS COMPASS ISLAND has not been SPALTed with Block 1 changes."

Mr. Applebaum wanted to know if there would still be a computer for the Type 11 periscope replacement.

"There is a computer involved in this periscope," answered Captain Gooding, "however, it is not the same type as the SDC. You take care of deck movement by stabilizing your line of sight with a little stable platform with rather coarse gyros on it, so that the computer involved in both proposals is a great deal simpler than the SDC."

## NAVIGATION COMMITTEE DISCUSSION

"I have one thing further to add about the Mark 2 Mod 0 question," interjected Mr. Cestone. "I want to point out that when it was in the laboratory it was tuned up to ultimate and this could explain why it performs the way it has.

"We have been very careful. This is the instrument we have been using to measure heading sensitivity, so we took a lot of pains to make sure that all the circuits were tuned to peak."

"Is the reason for your shopping for a better Type 11 based on a desire for more reliability or more accuracy or both?" asked Captain Styer.

"Both," replied Captain Gooding.

With no further questions or comments, Admiral Smith called upon Dr. Craven for the Systems Appraisal Committee Report.

## SYSTEMS APPRAISAL COMMITTEE REPORT DISCUSSION

"The purpose of my report," began Dr. Craven, "is to examine reduction of CEP beyond the values now specified by the Technical Development Plan. In looking at this, we gave no consideration to the need or desirability for reduction in CEP, nor did we attempt to analyze the requirements to achieve any specified goal. Instead we looked at and tried to identify various successive barriers to the reduction of CEP and we considered what would be required to demonstrate that we had indeed reduced the CEP. We tried to get some feeling for the associated magnitude of the research and development, and the systems change required to remove each particular barrier for reduction of CEP as we were able to identify it. Finally, we considered the probable reduction in CEP that would thereby accrue if we eliminated that barrier and were left with the next one.

"In order to place the problem in perspective, we felt that it was first necessary to review the experience with the A1," summarized in figure 1, to ascertain which limits may have already been reached.

"Analysis by the Applied Physics Laboratory of 14 SDAP shots on the 1100-mile range indicates a total system miss distance in range of 360 yards with a 1 sigma of 780 yards and in cross range of -720 yards mean bias with a 1 sigma of 1480 yards. The contributions to this total by navigation, fire control and missile were determined from detailed measurements at SDAP. These engineering estimates were derived from a large number of sources, including some that were purely simulated, to arrive at what the variation would be.

"The figure shows the mean bias for each one, the sigma, and contribution. From this we discover that in the range we have an unexplained residual of 430 yards and a sigma in that residual of 320 yards. In cross range, when we get all the contributions, we have an unexplained residual of 120 yards to the bias, and this has a sigma of 600 yards.

SYSTEMS APPRAISAL COMMITTEE DISCUSSION

MISS DISTANCE AND SUBSYSTEM MISS CONTRIBUTIONS (YARDS)		
	RANGE MEAN	SIGMA
NET MISS	+360 YDS	780 YDS
NAVIGATION	- 50	680
FIRE CONTROL	+120	260
MISSILE	-140	280
TOTAL CONT.	- 70	
UNEXPLAINED RESIDUAL	+ 430	320
CROSS RANGE		
	MEAN	SIGMA
NET MISS	- 720 YDS	1480 YDS
NAVIGATION	- 500	880
FIRE CONTROL	- 80	120
MISSILE	- 20	340
TOTAL CONT.	- 600	
UNEXPLAINED RESIDUAL	-120	600

Figure 1

"Now, the first question we asked is: Does this unexplained residual indicate that there are some things that we have not measured properly or some contributions that were missing? At first glance, the unexplained residual looks pretty big, for the 430 yards is larger than the net miss, and every time we would try to explain it, we only made things worse insofar as indicating what the residual was. On the cross range, unexplained residual is, however, low in comparison with the others.

## SYSTEMS APPRAISAL COMMITTEE DISCUSSION

"The elements which constitute the unexplained residual are as follows:

- (1) There is an uncertainty in each measurement together with a very small statistical sample. This, by itself, means that we are going to get an unexplained residual. There is an expectant value in this unexplained residual which is an uncertainty in function of measurement.
- (2) The second possible cause is our failure to measure variables which we know to be significant and to substitute instead a single estimated value for each missile in the sample. In each missile flight, for example, it was not possible to measure all the contributions. In lieu of these measured values, we would use other calculations or other empirical evidence to determine a figure which we then applied to each missile as a mean value. Each missile, of course, was having a distribution around that mean value -- if indeed it was a mean value -- and then with a small sample, we get an unexplained residual.
- (3) The thing that worries us most is our failure to identify variables which are significant. In other words, we have not identified something which is contributing to the miss distance.
- (4) The final and also important possibility is the uncertainty in the bias on the range. If the shots indicated that we were shooting from all the same launch points to all the same impact points, it might be explained as uncertainty in the location of the range. Thus, if the range were 430 yards different than we thought it was, then the unexplained residual would be erased completely if that bias correction were applied. On the other hand, if the error were in the other direction, it would double our residual.

## SYSTEMS APPRAISAL COMMITTEE DISCUSSION

"Considering the four items in more detail with respect to the program, item (1) is the question of what uncertainty in measurement, with small statistical samples, could account for a certain part of unexplained residual. To do this, we must boldly assume -- and we think that it is a rather bold assumption -- that the engineers made a bold assumption in the estimate of what the 1 sigma in measurement was. If we assume that they are correct, then with a sample of 12 missiles we can expect the standard deviation of the mean to be 80 yards in range and 200 yards in cross range. Immediately the cross range falls to a value less than that 200 yards, so we can say that the cross range is certainly a reasonable value in terms of the uncertainty in the measurements with the small sample that we had. In a case where the known slop lies within certain limits, it may not be worthwhile to go hunting around to explain that unexplained residual, even though there are things in there that might be significant.

"On the other hand, with the range, we should expect a value of 80 and we have a value of 430. It is possible that our one sample could have so wide a spread but the probability of that occurrence is extremely low.

"Item (2) is the failure to measure variables which are known to be significant and the replacement of this by a single estimated value by each missile sample. A prime example of this in the A1 was our inability to measure the velocity increment at re-entry body separation, which was produced by an air spring. We were unable to measure the increment, particularly in these SDAP shots, because the Azusa system was not operative for these shots. Thus, we supplied an estimated range bias correction of 160 yards for each shot, with a sigma of 200 yards. This estimate was made in large part from the data on the flat-pad shots. In order to determine the velocity increment on separation from flat-pad shots, extrapolations were made from forward and backward extensions of the Azusa track. We carried the powered flight track forward and the ballistic track backward in order to find out what the intersection was.

## SYSTEMS APPRAISAL COMMITTEE DISCUSSION

"The efficacy of this approach is indicated by the fact that two shots in the sample showed a negative velocity increment for, when we extended the track backward, the calculations indicated that the thing had to slow down. So, some of the extrapolations are not of much use, and were replaced by some simulations based upon measured characteristics of each particular missile. To some degree, the engineering estimate is suspect, but assuming that the engineering estimate was correct, then the mean of the unexplained residual for a sample of 12 shots would have a standard deviation of 50 yards as a result of our failure to measure this quantity.

"So now we have two aspects which affect the unexplained residual as far as range is concerned: 80 yards from uncertainty in measurement and 50 yards from the failure to measure the separation accurately. These have to be RSS'ed to get the expected value, and that is a little too small.

"Regarding item (3), the failure to identify significant variables, two examples can be cited in the A1. In the initial analysis, the missile contribution due to drag of the re-entry body was computed on the basis of zero yaw oscillation and nutation of the re-entry body. Later analysis of these measurements indicated that such was not the case; subsequent computations revealed that the change in drag due to these motions resulted in negative corrections of approximately 260 yards for each shot. It turned out that all motions had been given effectively the same change in drag. This was the wrong kind of correction to explain unexplained residual and this value differed from the value in the APL reports. As a result of the changed correction, the unexplained residual becomes worse.

"Another example exists in the trajectory analysis, which is that for as-yet-unexplained deviations from expected propulsive characteristics, the guidance was required to compensate for X-axis divergence as great as 17,000 yards. The guidance has the program track and the guidance Q-matrix is continually correcting for X deviations from .



## SYSTEMS APPRAISAL COMMITTEE DISCUSSION

track. These deviations, to be successful with the linearization that is involved in the Q-matrix, must be relatively small. When we got as large as 17,000 yards, the guidance system was, on that shot, still correcting for it within the accuracies of the Q-matrix; but the question now comes up whether the linearization of the Q-matrix really applies for deviations of that order of magnitude.

Responding to a question from Mr. Applebaum, Dr. Craven explained that the Q-matrix changes the velocity-to-be-gained in accordance with the X and Y distances. Mr. Hoag inquired whether a modified, abnormal trajectory had been supplied into the analytical program. Dr. Craven assured him that such had been done, even though the results were not available to him at this time.

"I brought this up," continued Dr. Craven, "as an example of something that we can easily forget to include in our analyses. Later we have a more difficult time trying to explain it in the residual.

"The last factor, item (4), is most prominent with respect to the absolute geodetic location of the range. As long as the missile tests are made from a given launch point to a given impact point, this uncertainty is a factor common to all shots and will not change regardless of sample size. At present, the estimate of uncertainty of absolute location in the range extends from a low of plus or minus 200 yards as range, 1 sigma uncertainty, to a high of plus or minus 500 yards, 1 sigma uncertainty, in measurement. The difference depends upon whom you talk to! However, item (4) alone could reasonably account for the entire unexplained residual in range and, therefore, represents a primary barrier to demonstration of reduction in the CEP.

"Let me summarize what we are trying to propose by looking at the A1 shots. We see that there is already a primary barrier in the reduction of CEP, and that is the uncertainty in the range location. If we have a 0.25 n.m. uncertainty in range location, then the ability to demonstrate CEP's of less than one nautical mile is seriously compromised.

## SYSTEMS APPRAISAL COMMITTEE DISCUSSION

"If we have a very sloppy measurement, then each shot will show an unexplained residual. If you have a very sloppy measurement technique and everything else is all right, then we will get a flat distribution on the unexplained residual which will come out to be zero. The sigma will be very large. Even the impact location geodetic position can be washed out by shooting lots of shots. However, it is bad when we get a large sigma for each unexplained residual, as this means on each shot we will have a great deal of difficulty in analysis of the shot where each individual shot may have been a bad factor or bad contributor insofar as the performance was concerned. In this, I am assuming that sloppiness has a normal distribution and that enough measurements will average zero."

"It seems probable to me," observed Dr. Mechlin, "that with your very limited sample, the probable error of the probable error would be extremely high -- possibly as high as the probable error itself. I am certainly not surprised that the unexplained residual looks like the number you have been trying to explain with only 12 measurements."

"We were a little surprised," replied Dr. Craven, "when we put this supposed 80-yard measurement uncertainty through the statistical works."

"You are talking about the mean," said Admiral Smith, "and Dr. Mechlin was not."

"Using the engineering estimates that we had, we ran an infinite sample of 12 shots and then took the mean of each sample and plotted it out. If all the engineering estimates are correct, the mean would have a value of zero, but with a 1 sigma value of 80 yards unexplained residual. In our particular population sample of 12, we came up with an unexplained residual of 430 yards which puts the sample way out on the tail of the distribution curve.

"From our experience, we know we have a lot more things that are way out on the tail of statistical curves, but not that many more. This 430 yards is not an expected value for the unexplained residual -- not the kind of thing that can be explained as uncertainty of measurement."

## SYSTEMS APPRAISAL COMMITTEE DISCUSSION

"The sigma of the residual stays there and it is sloppy all of the time. The sigma is a function of each shot, and each individual shot can be sloppy in this thing all the time. I do not think the sigma is unreasonable in terms of how we measure. I do think we must improve our measurement techniques, particularly insofar as this separation phenomenon is concerned. Actually, if we really want to improve CEP, we had better get rid of this separation phenomenon completely."

"We can assume, then, from this series of tests," remarked Admiral Smith, "that we can neither confirm nor deny our methods of predicting CEP."

"On the basis of these tests, we can confirm that we have a CEP for a particular missile of between 0.75 and 1.25 n.m.," replied Dr. Craven, "and do it with a high level of confidence. It is in large part a question of adding bias conservatively."

Asked about the measurement of wind in the re-entry situation, Mr. Morton said, "We fired with zero correction in the fire control and then measured the winds downrange at the time of firing. We made the correction for the windage after flight. The wind readings were made by use of Air Force meteorological balloons launched from a downrange telemetry ship. We got the observed wind velocities, although they were possibly several hours off in the time scale."

"With the holes you find in weather down there," observed Captain Jacobs, "it would be pretty hard to coordinate after that time lag."

"We found the density measurement to be a much bigger problem," added Mr. Morton, "and we feel it has a much bigger effect than the windage."

"What is the relationship of these measurements to the synoptic prediction we are using?" asked Admiral Smith.

## SYSTEMS APPRAISAL COMMITTEE DISCUSSION

"We do not know, as we have not as yet been able to get good, unambiguous data of what is actually being used," replied Mr. Morton. "It must be very highly classified, as we have not been able to look at it as yet."

"Getting back to the wind and the density," continued Mr. Morton, "the curves used on SDAP shots are generally made up on the basis of a standard day. We have deviations from that set of values in the impact area that we are firing into, and the report covers this situation. Now, this bias essentially covers those values which are the difference in that area from the standard day. Similarly, we must define a sigma about when and how well we measure the wind. This gives us two problems on that to correct on all flights."

Asked about the windage and density contribution, Dr. Craven explained that the range contribution had been assessed at 0.01 n.m. with a sigma of 0.11 n.m. while the cross-range contribution was 0.03 n.m. with a sigma of 0.12 n.m.

"There is one thing we should be careful about," said Mr. Morton. "Since our sample has 12 missiles fired at a particular azimuth into the target area, the range bias will probably show up because of our approach to the impact area. The ORRT missiles will approach from a different aspect and the bias possibly will not show up with them."

Dr. Craven disagreed on this point, asserting that the bias will show with the ORRT shots, and Admiral Smith interrupted to ask if any similar analysis was being run on 12 A2 missiles.

"We have started the study," replied Mr. Morton, "but do not have all the data together yet. We have the impact data and navigation contributions, but we have not as yet broken down the missile and fire control contributions. We are doing it now, and I cannot give an estimate on when it will be finished. It depends on how we proportion our efforts."

## SYSTEMS APPRAISAL COMMITTEE DISCUSSION

"A considerable effort is required to minimize the uncertainty due to relative location of launch point and impact point, but it can be done," continued Dr. Craven. "Two different levels of effort must be distinguished: (a), demonstration of CEP for ranges of 1300 nautical miles and, (b), demonstration of CEP for ranges from 2000 to 2500 nautical miles. In the first case, both launch and impact points can be referenced to stationary land masses; in the latter, one point must be located in the broad ocean areas. For the land-to-land case, precise observations of TRANSIT and ANNA satellites will permit locations of such points to an uncertainty that should be of the order of 100 yards. To achieve this, accuracy, we will require oscillation from satellites transiting in different orbital inclination than we now have. As presently scheduled, the TRANSIT satellites will be programmed only for polar orbits and instrumentation does not now exist on Antigua for reception of TRANSIT signals. The location of a receiver at the impact site and the inclusion of non-polar orbits for geodetic satellites are essential requirements for eliminating range bias as a serious source of uncertainty.

"There are several more ways of approaching this range problem. One is HIRAN, which works well enough as long as your shot moves straight down along the chain all right; however, should you start wandering off at an angle, the results are not clear.

"The multiple orbits are needed because the satellite responds to an integrated gravity field and it sees one integrated gravity field as it moves in one direction and the other one in the other direction."

Dr. Craven explained that the different orbits resembled aircraft flights over a canyon when the aircraft was using altimeter feedback to maintain constant altitude; flying the long way of the canyon, the aircraft would hardly know it was over a canyon, while flying across the canyon would give sharply defined reactions.

"The satellite faces a similar problem," continued Dr. Craven. "in its response to the total gravitational field, when the anomalies are

## SYSTEMS APPRAISAL COMMITTEE DISCUSSION

more attenuated than the major sources. Thus, if you have anomalies with gradients that are sharper in one direction or another, a polar satellite orbit will not show them up."

"What assumptions do you have regarding the location accuracy needed for this analysis?" asked Admiral Smith.

"As a general statement, we feel that the range bias error should be at the least 0.1 of the CEP that we are trying to demonstrate. We feel this is almost a requirement because very small differences in the CEP itself make a significant difference, on paper, in the effectiveness of the yield and weapon. If you have a CEP of 0.7 n.m. and we give ourselves a 10 per cent error, we introduce a variance in the CEP extending from 0.63 to 0.77 n.m. The importance here is fairly obvious.

"We must also point out that it is more important to have exact geodetic location of the ranges than of the targets. Errors in the geodetic location of the range have to be added over and above the CEP, while the target figures can be computed within the CEP."

"When you talk of this 0.1 mile," observed Admiral Smith, "you must have concluded that it would take two different satellite orbits, and you must have translated that into a number."

"We did," replied Dr. Craven, "at 100 yards. Right now, we think we can locate to within one mile, and we certainly do not feel that there is any point to an effort to develop a CEP of 1.0 n.m. On the other hand, the committee suspects that anyone who talks about a CEP of less than 0.5 n.m. has been smoking illegal tobacco. However, if we can bring location error down to this 100 yards, which is close to 0.1 of the presumed CEP, we will be able to remove a big piece of this residual. The first step in doing this is to get geodetic satellites crossing in opposite directions near the launch area."

## SYSTEMS APPRAISAL COMMITTEE DISCUSSION

Mr. Morton observed that the report mentioned Ascension rather than Antigua; this was in error, because there is no present capability for non-polar orbit coverage of the South Atlantic, while this would be available at Antigua as also would the HIRAN capability.

Dr. Craven observed that the HIRAN was already burdened with an uncertainty figure of 0.25 n.m., but Mr. Morton explained that there was good reason to believe that the HIRAN survey had not been properly conducted, and that a resurvey of the area would reduce the uncertainty to 0.1 n.m. or less.

"We are going to re-run the survey immediately," continued Mr. Morton. "One of the problems here has been in determining the range area for the A3 and its 2000+ miles. We would like a temporary station in Ascension, and we would like two orbits over that area to get the general gravity field pattern in the impact area."

"It is no trivial item to set up a 2500-mile range," continued Dr. Craven, "even if we can find a land-to-land range area. There is a lot of instrumentation required and the set-up is a major effort. We have been trying to be realistic about it, as we were with the 1300 n.m. range at Antigua where we now have the equipment and instrumentation to make all the needed measurements. We are going to have to set up an A3 range station with the same equipment. First, we need the land-to-land range of 2500 miles."

Mr. Forter suggested Australia as a possibility; Captain Jacobs agreed that they have the range mileage in Australia, but the effort would involve some sizeable range safety problems.

"The inclusion of non-polar orbits for geodetic satellites is a requirement for eliminating range bias as a serious source of uncertainty," stated Dr. Craven. "The problem of determining absolute position in broad ocean area ranges is complicated by the movements of the observing

## SYSTEMS APPRAISAL COMMITTEE DISCUSSION

platform and uncertainties in its absolute velocity over land. Thus, the fix-taking capability of TRANSIT degrades according to the law that the error in latitude is equal to 0.05 of the error in east velocity in nautical miles per knot, while the error in longitude equals 0.2 of the error of north velocity. A 1-knot error in north velocity would give an error in longitude of 0.2 nautical miles over and above the errors that would normally accrue from the TRANSIT system."

Captain Gooding agreed that the TRANSIT figures were essentially the same as those he had, although his figures were taken in track and cross track while Dr. Craven took his figures from North and East.

"At present," continued Dr. Craven, "velocity is not provided by any system aboard ship with the requisite accuracy. However, there is a technique of taking fixes from TRANSIT observations which eliminates the need to measure velocity, if precise knowledge is available -- 1 part in  $10^{11}$  -- of the absolute magnitude of the frequency standard aboard the satellite and the receiving station.

"Because of its quiet environment, the standard presently programmed for the satellite appears to have the required long-term stability, but the standards presently employed in the TRANSIT receivers are inadequate. Rubidium vapor standards are presently available which show promise of this stability, but none are presently scheduled for incorporation in operational receivers. I think we need first to demonstrate that the first statement about satellite stability is true; if the stability does not hold and if the rubidium vapor does not quite work in the receiver, we might have a difficult problem. The solution is not as assured and positive as it might seem."

"Data on the satellite are available," said Mr. Morton, "but we still have to get some data on the rubidium standard. We calibrated the satellite by itself by looking at a single station or two adjacent stations. The values are down where Dr. Craven would like to see them, and the repeatability within a given station indicates that the oscillator stability in the satellite is holding the required accuracy."



## SYSTEMS APPRAISAL COMMITTEE DISCUSSION

On a question from Admiral Smith, Mr. Morton explained that there were three variables in this: position errors, velocity errors, and frequency errors, and that all three errors could be present to affect a reading.

"When you acquire a TRANSIT," remarked Dr. Craven, "you have uncertainty because of its location in reference to you, because of our unknown velocities, and because of differences between our reference and the satellite reference. We have three unknowns, and we are trying to get it down to two unknowns within a specified order of accuracy."

"We feel that we can eliminate one of the inaccuracies by stabilizing frequencies at the receiver," said Mr. Eyestone. "I think we could get the computations solved even without improving receiver stability if we went to a more complex computer, and this seems to me to be the way to go."

"The improved receiver will also cut down the time needed to take a TRANSIT reading," said Dr. Craven, "even though the short time reading would be somewhat degraded in accuracy over the normal reading time. The degradation for a short reading would still give the accuracy we are getting today."

"To summarize, then, the present lack of range location knowledge is a serious bar to any demonstration of CEP's of less than one mile. The problem can be overcome for the 1300-mile range by using a non-polar geodetic satellite and installing suitable receivers. The broad ocean area problem may be resolved by the addition of equipments to maintain absolute frequency standards and by techniques for precise determination of ship's velocity."

Asked about HIRAN, Dr. Craven explained that he did not have any real confidence in the system; certainly if the new survey differs materially from the earlier one, then consideration will have to be given to more surveys to find which of the first two was right, and one begins to wonder about how many surveys would be needed to determine the sigma in measurement error, as well as the bias.

## SYSTEMS APPRAISAL COMMITTEE DISCUSSION

"We have some experience," said Mr. Morton, "with the long-range HIRAN system which went from Japan all the way across the States. We found the range error was very small, but because of a small deviation in angle, there was a fairly sizable cross range. Applying HIRAN locally to the Antigua MILS area, we could expect a fairly accurate survey of that area. We know what is causing part of this range bias in this particular Antigua MILS. The LORAC station which surveyed in originally on one of the islands was not ever surveyed correctly. There ought to be improvement immediately on the Antigua MILS by a HIRAN survey."

"If a short range HIRAN survey is conducted properly, it should be fairly precise for the area. The big problem is going beyond Antigua into the 2300- to 2500-mile impacts where HIRAN is not adequate. Here we must get a temporary station and two types of orbits in that general area."

"Next, we consider the weapons system," continued Dr. Craven. "Although navigation has been a major contributor to CEP in the early classes of FBM submarines, it appears that in future systems many other factors are dominant and should therefore be considered first."

"Figure 2 is an incorrect projected contribution for the SSB(N640) system at a range of 2500 nautical miles. A couple of figures should be raised a little; I have a breakdown in a later figure. I presume after this meeting is over we may have some argument with several figures here, but this is where we stand now."

"I think by this time everyone knows what a double cubit is. As a measurement, it is partly facetious, partly serious. We have always had a problem in talking about CEP's and what we have done, what we are about to do, and what we are sure we can do in the future. The advantage of double cubit as a measurement lies in the fact that it varies between 35 inches and 41.4 and it has a nice bias on the side. As you will see later, the ell has the advantage of running from 27 inches up to 45 inches. It will help, I think, in talking about things, to have values in double cubits or ells. If you do not like them, they can always be converted into yards and other conventional units."

SYSTEMS APPRAISAL COMMITTEE DISCUSSION

MISS CONTRIBUTION FOR A3-SSBN (640) SYSTEM  
RANGE 2500 N. M.

	RANGE	TRACK
SEPARATION & RE-ENTRY	1050 DC	1400 DC
GUIDANCE	570 DC	535 DC
FIRE CONTROL	427 DC	680 DC
NAVIGATION	400 DC	800 DC (400 POSITION 30 SEC AZIMUTH)
TOTAL	1330 DC	1820 DC

CEP = 1860 DOUBLE-CUBITS (YDS)

Figure 2

"I would like to discuss another point here on navigation. In the report it says that accuracy can be maintained if an eight-hour fix-interval TRANSIT mode is employed; it then estimates that the SSB(N)640 is able to maintain RMS position of 400 double cubits in latitude and longitude and from 25 to 30 arc-seconds in azimuth.

"I would add the following sentence to the report: 'If an eight-hour fix-interval TRANSIT mode is employed and TRANSIT is able to demonstrate 0.1 nautical mile CEP, then the navigation estimates on figure 2 will apply. If we are not able to demonstrate 0.1 n.m. but can demonstrate

## SYSTEMS APPRAISAL COMMITTEE DISCUSSION

something slightly under 0.2 n.m. CEP and we are able to operate in the so-called fixed TRANSIT mode -- one about every three hours -- then these estimates will still be good.' Thus, the navigation figures are the best that we can get at that time, working in a mode which hopefully permits us to operate an eight-hour fix but probably will require almost continuous feed-in of the useful fix information.

"The largest contribution in this projection, even with the correction, results from the combined effect of separation errors and the vagaries of the re-entry environment. If increased accuracy is a goal, then it is unlikely that the present warhead will be retained. We have a very nice analysis on the POLARIS A3 missile accuracy, but if one asks what happens when one puts a single re-entry body on the A3 system, the analysis is a little more difficult to project as to what these errors will be.

"Figure 3 is a breakdown of what I would call modified figures from this A3 missile system projection report, and shows the misalignment-re-entry contribution to be about 200 double cubits in both range and track. The re-entry winds accounted for 643 double cubits in both range and track, while the density accounts for 250 in range. The uncertainties in the re-entry body mass accounts for 40 double cubits. The second stage flight errors apply rotations within a certain amount of slop to the re-entry body, and provide little yaws to the re-entry body. This produces about 300 double cubits in both range and track.

"I am not certain what this re-entry body separation term is, but I think it refers to uncertainties at separation which provide a 57 double cubit error in range. The little ejection rocket causes many problems, and is the largest contributor -- 950 double cubits in range and 150 in track. We are still not too sure about the second stage jet wake effects.

"The term 'Misalignment-Re-Entry' covers the whole re-entry system, and is drawn from the misalignment possible in the whole re-entry structure as well as each individual body. For the support system, it

SYSTEMS APPRAISAL COMMITTEE DISCUSSION

includes the thrust offset and the support system tilt; for the re-entry bodies, it covers the c. g. lateral offset and the tiltout angle. In terms of a single REB, the information amounts to a guessed contribution, based on the figures we have for a cluster.

"The flight attitude is given in the second stage flight errors and includes the second stage attitude, roll attitude rate, pitch rate, and yaw rate.

MISSILE CONTRIBUTION		
	RANGE d. c.	TRACK d. c.
MISALIGNMENT-RE-ENTRY	200	200
RE-ENTRY WIND	643	643
DENSITY	250	---
REB MASS	40	---
2ND STAGE FLIGHT ERRORS	300	300
R/B SEPARATION AND THRUST LIMITATION	57	---
R/B EJECTION ERRORS	950	150
2ND STAGE JET WAKE EFFECTS	<u>200</u>	<u>20</u>
RSS	1240	750

Figure 3

## SYSTEMS APPRAISAL COMMITTEE DISCUSSION

"Some of the range and track contributions are the same, and this is a function of the design. In some of the contributions, we feel that the contributions are about equal; others we know are somewhat unequal.

"Our entire analysis of the re-entry misalignment is based upon a Lockheed report on 15 January 1962. We used the cluster information, of course, and from it we projected the problem to a single re-entry body and what it would do. Lockheed felt that the material of the report was still valid for our purposes; our judgement enters the problem in the conversion to a single-body system. This action conversion has its difficulties because the three bodies have different kinds of range and track errors, depending upon their orientation. In a sense, we have had to split the range and track errors to do it."

"Is this using a high  $W/C_D A$ ?" asked Mr. Forter.

"No, we worked with the present  $\overline{W/C_D A}$ ," replied Dr. Craven.

Upon questioning, Dr. Craven explained that the wind data had been taken from the report. Dr. Wilson added that the report assumed the 90 per cent prevailing winds determined an applied bias for fire control. To a question from Captain Sanger, Dr. Craven noted that the wind correction seemed too large to indicate that it had been based upon synoptic winds. Captain Sanger agreed that the number was too large, compared with the normal corrections supplied to the fire control system.

"On what basis do we feel able to estimate synoptic winds over Russia?" asked Admiral Smith.

Captain Sanger replied that the data came from Dahlgren and was based on Russian information. Captain Jacobs added that the Russians have reported weather information from stations all over Siberia and that, based upon the Navy's observations during the Korean action, it was good information; the Navy had many opportunities to compare the prediction with the actual weather.

## SYSTEMS APPRAISAL COMMITTEE DISCUSSION

After checking the report, Dr. Craven explained that the wind was based upon predicted atmospheric perturbations developed on a seasonal basis and from synoptic wind information.

Admiral Smith asked if there were a way to compute these error contributions in terms of the flight periods -- powered flight, separation and re-entry. Dr. Craven replied that the re-entry contributions as estimated would still apply, but that the figures for powered flight just presumed the missile contribution and did not include guidance figures.

"There is a residual that should be considered," continued Dr. Craven, "covering the yaw and pitch that happen to exist at the end of powered flight. This had been included in the Second Stage Flight Error contribution."

"In a sense, then, this is a difference between the conditions at the end of powered flight, and at the point of maximum altitude," said Admiral Smith. "If we could take measurements of sufficient accuracy at those points, we could resolve this part of the problem. Right now we do not have a way of getting such an error breakdown or of taking these measurements."

"The problem is a way of measuring them," agreed Dr. Craven, "for it is much the same as measuring velocity increments during separation. Even if we are able to measure them, can we identify the sources of the velocity increments? As far as I know, without additional instrumentation, we cannot do it."

"I am suggesting that we look at something external to these things that are supposedly doing the job," said Admiral Smith. "Right now, we are pulling ourselves up by our own bootstraps. Assuming we have the system shown in the figure, we have checked the overall error content and the error content in the sub-divisions I suggested -- which we cannot do -- and we find as a result that the error does not come out as predicted, what do we do then?"

## SYSTEMS APPRAISAL COMMITTEE DISCUSSION

"If we had the ability to measure the re-entry body after separation, we could split the error content between the top and bottom four entires," replied Mr. Morton.

"Further, we have recent data about the 950 double cubits assigned to the re-entry ejection," observed Dr. Wilson, "for we have just finished the qualification program of those rocket motors. Although we had some errors in instrumentation, we did find that the one sigma variation in total impulse was one-third of one per cent. Earlier we had thought it would be one per cent. This will reduce the 950 cubits somewhat."

"In other words, the 950 may be pessimistic in range, but the 150 seems optimistic in terms of track?" asked Captain Sanger.

"I do not know," replied Admiral Smith, "but certainly there is more to both these error figures than the total impulse. If the impulse is wrongly applied but only affects the up-and-down situation, it will not change the track error by much. The directional sensitivity is greater in the lateral than in the vertical."

"The impulse error here was assumed at 1.53 per cent, and contributes about half of the total in the REB ejection errors," explained Dr. Craven.

Commander Julian added that a substantial portion of that error would be caused by the pressure fields built up under the body during ejection.

After a coffee break, Dr. Craven summarized the previous discussion by re-screening figure 3 and cautioning members that there was no point in arguing about precise values, as he had deliberately employed the double cubit as his measuring technique to avoid these arguments.



## SYSTEMS APPRAISAL COMMITTEE DISCUSSION

"What I was trying to point out," continued Dr. Craven, "was that we have two errors -- one concerned with the thrust determination separation phenomenon, and one connected with the re-entry phenomenon. They are both the biggest contributors of CEP uncertainty. If we can knock only one out, we will not make a sizable dent in CEP, but if we eliminate both, we will make a considerable improvement.

"It is the unanimous conclusion of the Committee that no meaningful reduction in CEP can be achieved unless a new re-entry body and post-separation guidance system is developed. We feel that you must carry the existing guidance system through the separation phase with the re-entry body. In addition, we must increase the  $W/C_{DA}$  to reduce the effect of winds over target. If we do this, a reasonable goal -- and this is a goal that we feel is attainable -- for the total sub-system contribution could be about 200 ells in range and 200 ells in track."

Dr. Craven explained again his use of the ell rather than the yard, adding that should the CEP come out as 300 yards rather than 200 yards in range and track, he would not be surprised.

"With your 1.3 ell-factor, that would mean a degraded ell," commented Admiral Smith.

"Largely, it is a measure of how serious we are about the 200 yards yards," replied Dr. Craven.

"Would the use of the A2 second stage separation mechanism change these figures any?" asked Dr. Mechlin.

"We would still have a problem," replied Dr. Craven, "for it has a severe uncertainty in the air spring together with the uncertainty of time in the acceleration picture -- the uncertainty of that split second when you reach zero acceleration. Once you stop acceleration, the problem is not as serious."

## SYSTEMS APPRAISAL COMMITTEE DISCUSSION

"What sort of assumptions did you make about the contributions of the fuzing error to the range error?" asked Captain Sanger.

"We assumed the use of a ground burst system and recognized that we have a real fuzing problem," answered Dr. Craven. "We are coming in at a much sharper angle, about 36 degrees. We take the fuzing error and divide it by the cosine of that angle to give the total error. The fuzing error is quite significant and the fuzing problem is another phase of the redevelopment program. We would be very surprised if we were not required to have an air burst option or an air burst fuzing system.

"If a new mid-course guidance is considered, then the question of stellar monitoring will inevitably be raised. Such a device depends upon the measurement of an angle between a vector directed from a missile to a star and an earth-oriented vector for its effectiveness.

"The importance in this system is to have accuracy. You are relating an angle between an angle to a star and an earth-oriented vector. If there is slop in the measurement of the earth vector, the fact that you can measure a precise angle between earth and star vectors is not going to help much. The effectiveness of this system is a function of the extent to which the error introduced by azimuth dominates the error introduced by measurement of local vertical or geodetic position or velocity. In a sea-based inertial system, improvements in azimuth are related to improvements in our ability to predict position and local vertical.

"The very nature of our system is such that as we get improved predictions in vertical and in position plus velocity we always get some gain in azimuth. Therefore, there is some doubt that the unbalance in the azimuth-local vertical relationships which make stellar monitoring attractive will apply. The Committee did not have sufficient information to resolve this question; and its tentative conclusion is only a value judgment of the Chairman. I feel that this would be a very delicate trade-off

## SYSTEMS APPRAISAL COMMITTEE DISCUSSION

if we go to stellar systems without improving the ability to get local vertical or position and velocity. Position and velocity cannot improve the local vertical of themselves. This is position and velocity in the ship at the time of making the observation, plus the integrated error up to the time the observation is made.

"Recall that the point of our exercise here is to take each error source and cut it down as much as possible, and particularly to concentrate on the worst offenders. Now a re-entry and post-separation guidance system error of 200 ells in both range and track results in a system CEP of 1200 double cubits."

On a question from Mr. Burg, Dr. Craven stated that his statements were related to a single-star fix, but they applied equally to a two-star fix.

"In using a two-star fix," observed Mr. Forter, "you will have to consider platform drift, which will always be there. With a two-star fix after separation, you of necessity extrapolate back an additional geodetic error from launch and a vector error in azimuth which will contribute jointly to the problem. This is simply because you have a velocity vector introduced by the platform drift at the time of separation."

"The only unbalance in the system at present," added Dr. Craven, "comes from a large error in azimuth. Similarly, the most useful improvement needed for a stellar system would be azimuth correction."

"With two-star readings, where you are only trying to get azimuth," asked Admiral Smith, "can you not limit the earth-oriented reference to the position at which you get it?"

"You could if you were sitting in one position and not moving," replied Dr. Craven, "but there is an initial velocity uncertainty. A land-based system has its position down exactly and the initial velocity would be exactly equal to the earth's rate. When we have exact position,

## SYSTEMS APPRAISAL COMMITTEE DISCUSSION

we automatically have the earth's rate. When we add motion to this positional information, we lose the value of knowing our position in terms of knowing our absolute velocity. We need to derive a velocity vector from this."

"In terms of getting calibration," said Mr. Flood, "the position sensitivity of a two-star stellar fix is 100 feet per 1 second of arc that you make in the measurement. This is irrespective of range or anything because after you have made the stellar fix, you go back and correct your geodetic position of launch. I want to impress on you that, positionally, this 100 feet of misalignment is a very sensitive thing. Of the three sources of misalignment, one is the misalignment of the vertical at launch which cannot be done perfectly. The second is the misalignment that occurs during flight due to gyro drift where the vertical you are using as an earth reference drifts during flight. The third source of error is the actual accuracy of the device itself. Whatever this comes out to in seconds, it need only be multiplied by 100 feet to get a true error in miss at the target if your launch position is wrong.

"The azimuth is not as sensitive and it is range-dependent because it is multiplied by a partial of miss as a function of range. If your vertical is off a little and you make an azimuth measurement, you can supply correction through a partial equation differential."

"There is another mechanism involved in this position measurement," said Mr. Eyestone, "which is worth consideration. The gyro drift incurred while going up to make the measurement becomes a flight error even if a star fix is not taken. If you take a star fix from the drifted platform to supply a correction figure, then you are making another flight error. I believe the two errors are additive and nothing can be done about them."

"Next, I would like to cover," continued Dr. Craven, "the remaining major error sources. Guidance, fire control and navigation are in approximately equal position as contributors. This is a misleading summary."

## SYSTEMS APPRAISAL COMMITTEE DISCUSSION

the ability to improve navigation is highly dependent upon fire control to receive, process, and transmit information with precision matching the navigation improvement.

"For example, it would seem that the ability to measure ship's velocity permeates almost every phase of the system. As we have seen, it has a profound effect on the ability to utilize TRANSIT. It is of prime importance in establishing local vertical in the missile and independent measures of velocity are significant factors in the damping of SINS. At the present time the guidance and fire control systems are digitalized so that the last bit represents 0.264 feet per second -- 0.15 knots -- in velocity. If the SSB(N) 640 navigation system performs as advertised, it will provide better velocity information -- approximately 0.1 knots -- but the improvements in this measure will not be translatable through the guidance and fire control system. Thus, the Systems Appraisal Committee identifies guidance and fire control, considered together, as the next barrier after the re-entry body in CEP reduction.

"Major improvements in fire control can be achieved if the alignment method employed a digital alignment loop from SINS directly to the guidance system, thus eliminating the need for a resolver in the fire control system.

The alignment loop has two parts. It has a so-called coarse align, which is a misnomer because this coarse align does not bear the same relationship to fine align that coarse erection bears to fine erection. Coarse align is a precise alignment with respect to the SINS system that is carried through the fire control by means of resolvers. The fine align adds a correction from the optical system of the misalignment between the missile reference axis and the SINS reference axis through the deck plane of the ship. The first big improvement is the removal of a large amount of the slop that occurs when we carry the coarse align from the SINS through the fire control and into the missile.

## SYSTEMS APPRAISAL COMMITTEE DISCUSSION

"The second item -- quantizing the computers to 0.15 foot per second as the incremental velocity bit instead of 0.264 foot per second, and modifying the time constants in the erection loop -- will permit us to utilize the better velocity information in the erection of local vertical.

"The third point is the measurement of the 'rounding-off' error in the Q-matrix of the guidance system, as compared with the DGBC computation which uses the entire Q-matrix words. At present we are using a value to round off error in the Q-matrix that is not as accurate as we could be using.

"Fourth, we need to use a more exact equation for deck tilt. Many of the computations are done in terms of deck plane rather than the horizontal plane, adding a correction for roll to correct from the deck to the horizontal plane. This has not proven itself out well -- the deck tilt correction is only approximated in the equation."

Mr. Burg observed that the only time the submarine has a deck tilt correction of any sort is in the optical alignment error level, and then it is supplied only in roll because it hinges on a matter of a few seconds. "For the coarse alignment," continued Mr. Burg, "we do not use precision resolvers in the transmission, which gives us about a 3- to 6-minute error in transmission. In the fine alignment we go from precision resolver to precision resolver with very little difference in accuracy."

"Regarding our fifth item," continued Dr. Craven, "for improvements in fire control, we suggest installation of a new optical alignment system. Because this change would only provide 5 ells improvement in the total fire control contribution, it should be studied with a concern for the cost versus CEP tradeoff. This would affect the fine alignment loop and improve it, while the digital transmission will affect the coarse alignment loop."

## SYSTEMS APPRAISAL COMMITTEE DISCUSSION

---

"Even the fine alignment is not that fine," observed Mr. Burg, "for you have a peak error of about 36 seconds."

Dr. Craven went to the blackboard to define the problem of perfect alignment of the SINS orientation with the ship's heading. "If the missile were structurally aligned to the SINS," Dr. Craven explained, "we would not need this fine alignment at all nor the optical system. As it is, we take a target bearing and ship's heading to define an angle which is carried over to the missile. However, this angle must be corrected for the misalignment between the SINS and the missile, and this correction data is supplied from an optical line-of-sight system. The correction is added to the digital value and, of course, must be supplied in digital terms.

"So, we suggest that the major change in the optical alignment system would be a change in the optical system itself. I am not sure that it is worth it."

Mr. Burg mentioned that problems could exist in terms of analog to digital translation that should be looked at carefully; he also cautioned against getting involved in major changes which might only add a fractional improvement, such as 15 minutes in 360 degrees.

---

"If you wonder," said Dr. Craven, "where my committee gets the information for figure 4, it came from the report of Project BULLSEYE, with some help from knowledgeable personnel who briefed us on improvements since this project."

Dr. Craven explained that his committee had several choices open to it in getting the information for this report; they picked the most effective means available for each of the various subject areas and added the committee evaluations on top of the source material; in some of them, the committee made some value judgments over and above anything suggested by the source material.

SYSTEMS APPRAISAL COMMITTEE DISCUSSION

PROJECTED MISS CONTRIBUTION ASSUMING STEP IMPROVEMENTS IN GUIDANCE, FIRE CONTROL & RE-ENTRY.		
	RANGE	TRACK
SEPARATION & RE-ENTRY	200 ELLS	200 ELLS
GUIDANCE	256 ELLS	301 ELLS
FIRE CONTROL	280 ELLS	350 ELLS
NAVIGATION	400 DC	800 DC
TOTAL	585 ELLS	940 DC
CEP = 900 CONSERVATIVE ELLS		

Figure 4

"We think that BULLSEYE is a pretty good study," continued Dr. Craven, "in terms of the fire control track and range contributions of 280 and 350 ells. Based on this study, we recommend that our fifth suggestion -- concerning optical improvements -- not be attempted if major improvements in the CEP can be obtained elsewhere."

"Then your value judgment in this," commented Admiral Smith, "includes the likelihood of obtaining some improvements before deciding whether to go for other improvements."



SYSTEMS APPRAISAL COMMITTEE DISCUSSION

"Next, the complementary changes in guidance," resumed Dr. Craven, "which should include the use of a more accurate clock -- accurate to one part per million rather than fifteen. We already mentioned the improvement in quantization of guidance computer bits, the reduction of round-off error in the guidance computer, and the reduction of alignment errors by using a more accurate resolver and improving the gimbal structure. Finally, we suggest the use of improved gyros and accelerometers. In the material of figure 5, the numbers given for March 1962 can be fairly well demonstrated by tests. We have vibration tests done on a rotating, centrifuge device; the alignment errors can be determined by table tests, as can the gyro errors; acceleration errors can be checked on the centrifuge; and the computer errors can be inferred from the very characteristics of the computer.

MK 2 ERROR SUMMARY - 2500 N. M.						
	MARCH 1962		PRESENT		POSSIBLE	
	YARDS		DOUBLE CUBITS		ELLS	
	R	T	R	T	R	T
GUID. COMP.	270	53	180	53	89	30
ALIGN. ERROR	430	468	114	263	69	30
GYRO	652	873	306	370	155	30
ACCEL.	704	409	431	275	170	30
VIB. EFFECTS	12	31	12	31	12	30
RSS	1090	1070	570	535	256	30
CEP	1270		649		320	

Figure 5

## SYSTEMS APPRAISAL COMMITTEE DISCUSSION

"Getting on to figure 6, if we obtain these improvements in the fire control, it will be vital to use the potential which the development program has already gained for us in navigation. In particular here, we suggest the application of electrostatic gyros (though you may think us over-optimistic) or the development of conventional gyros of comparable performance, coupled with improved techniques for calibration of the missile alignment at sea, and the frequent use of precise fixes such as can be gained from TRANSIT with the corresponding 0.1 n.m. position accuracy. These should, we feel, reduce the navigation contribution to 300 ells in range and 600 ells in track.

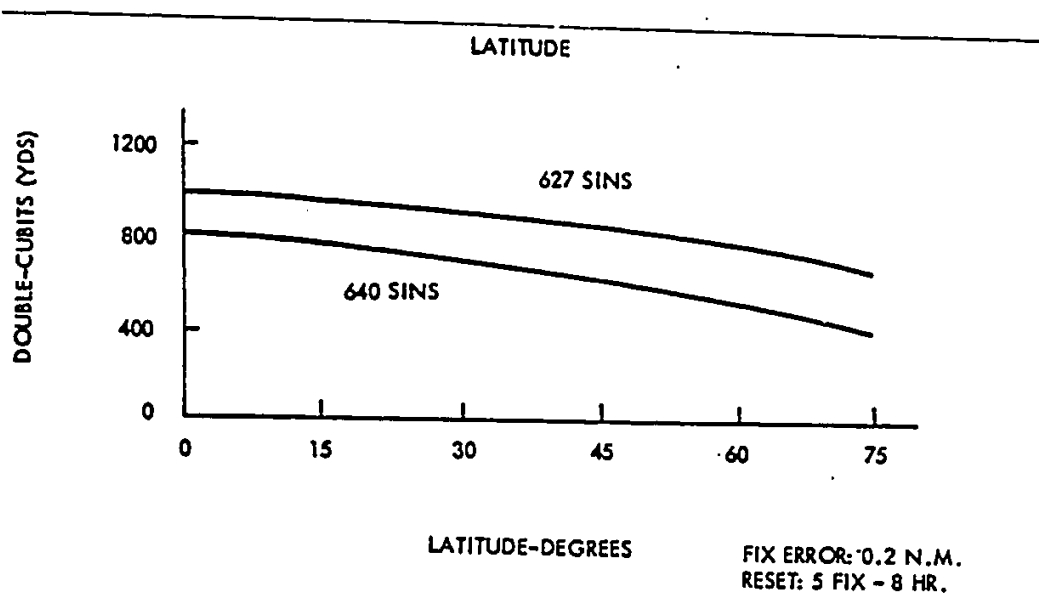

Figure 6

## SYSTEMS APPRAISAL COMMITTEE DISCUSSION

"You might question the advisability of taking frequent TRANSIT fixes, each of which requires about 20 minutes operation at periscope depth. A suggested alternative would be the use of a limited number of bottom transponder beacons which the submarine could use after an accurate TRANSIT fix to relocate itself as needed in a continuous or semi-continuous mode. There are two possibilities in this system -- one where the submarines plant the transponders as needed, and the other where we have an elaborate array of beacons set down in a prescribed network arrangement. The first idea is not costly; the second is very expensive. Both systems have security problems.

"The advantage is that the submarine can make precise fixes based upon TRANSIT information without having to come up to periscope depth every few hours. An alternative would be the improvement of the bottom-fix techniques. Right now we feel that the bottom topography has a 1-sigma value of 0.25 n.m. and would require a very substantial development program to bring it down to the 0.1 n.m. value that we can get from TRANSIT."

"Is this a question of location of bottom features, or the method of making measurements and calculations?" asked Mr. Eyestone.

"Basically, it is very easy to show," replied Dr. Craven, "that we can get much better than 0.1 n.m. fixes with respect to a transponding beacon arrangement set on the basis of a TRANSIT fix than we can by bottom topography fixes taken on the basis of the same TRANSIT fix. We do have the ability to relocate ourselves in terms of bottom features but it is not as accurate and will require a development program to improve the accuracy.

"There is a study by Sperry on this area. Working with one beacon, the submarine must cut a very tight circle around the beacon and I think that it would be regarded as an undesirable maneuver, even though it can be done."

## SYSTEMS APPRAISAL COMMITTEE DISCUSSION

"I think this is a gross over-simplification," remarked Mr. Cestone, "for there have been many experiments with this, and we have run into many problems simply in trying to make the surveys. The submarine often cannot find out where the beacon is; the submarine must know where he is operating, how deep the water is, what kind of sonic distortions may occur due to refraction and the water structure. It is no simple problem."

"I think that it is possible," said Captain Gooding, "by any of several methods to decrease the fix error to 0.1 n.m., but it may well be that this transponder is not the best method."

"And all these methods," added Dr. Craven, "require developments beyond what we now have. The system performance in figure 6 covers the heading error for the 627-Class and 640-Class. It does not reflect system performance as there are no longitude components shown.

"Figure 7 covers the longitude and the figures, as you may note, are about double those on the chart in terms of latitude and longitude in the 8-hour mode where we use the 0.2 n.m. fix. That is why I qualified my earlier words about the 640-Class navigation error. .

"Of some significance is the term we used for azimuth in the mode shown on figure 8, as it is within the bounds projected for the 640-Class SINS. We used 30 seconds of arc as azimuth and the results suggest that by using the best position and best azimuth available, it is very possible that we can obtain the figures quoted for the system earlier."

"You say it is possible," observed Admiral Smith. "How about its probability?"

"For the probable," replied Dr. Craven, "I would say between 400 and 800 yards in latitude and longitude, and about 25 to 35 seconds in arc."

SYSTEMS APPRAISAL COMMITTEE DISCUSSION

PRESENT SYSTEM PERFORMANCE

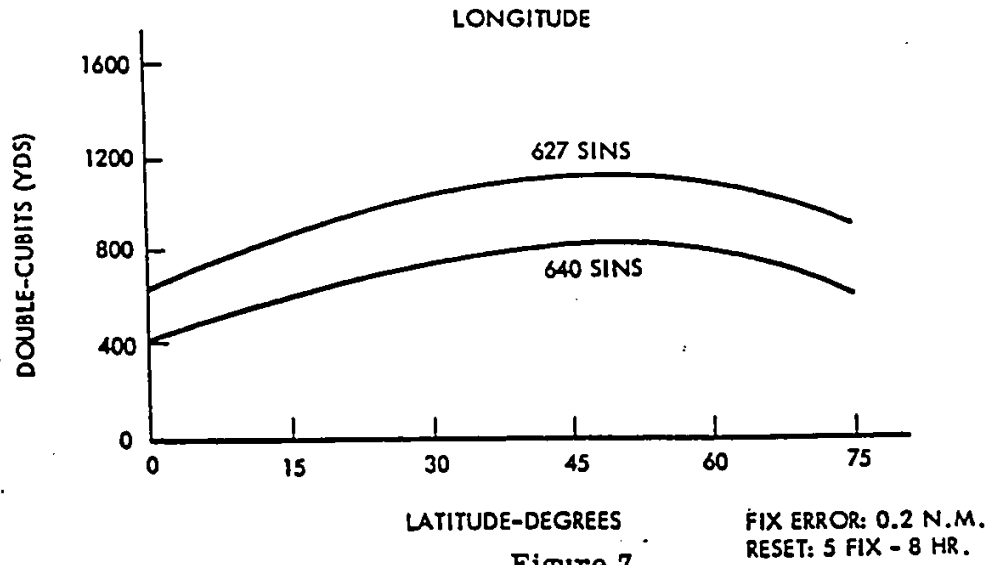

PRESENT SYSTEM PERFORMANCE

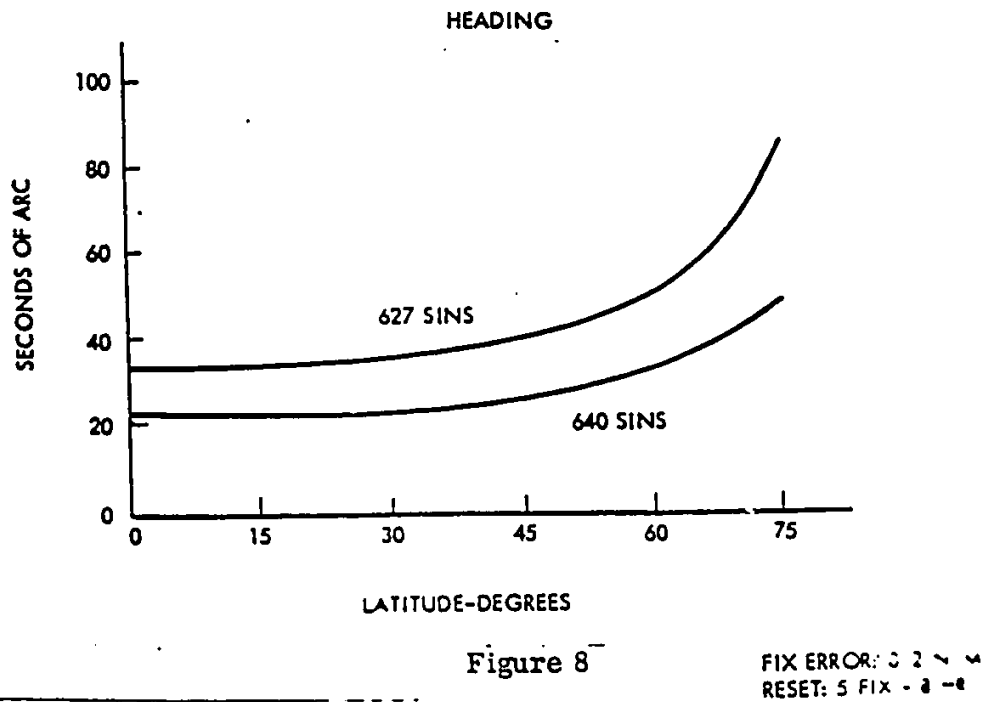

## SYSTEMS APPRAISAL COMMITTEE DISCUSSION

Mr. Cestone asked of the difference between the two systems, and Dr. Craven explained that the difference was largely in the azimuth monitor. Mr. Cestone then observed that the system should not have better performance at high latitudes, as the azimuth monitor starts to lose its value at sixty degrees or so.

"Figures 9, 10, and 11, show advanced system performance," resumed Dr. Craven, "given most advisedly in the terms of ells rather than yards. If we can use the ESG monitoring, the system will be able to perform at sea with the performance indicated by land tests. This performance uses the ESG purely as a gyro monitor, rather than as a navigator, and the system to do this is now under development.

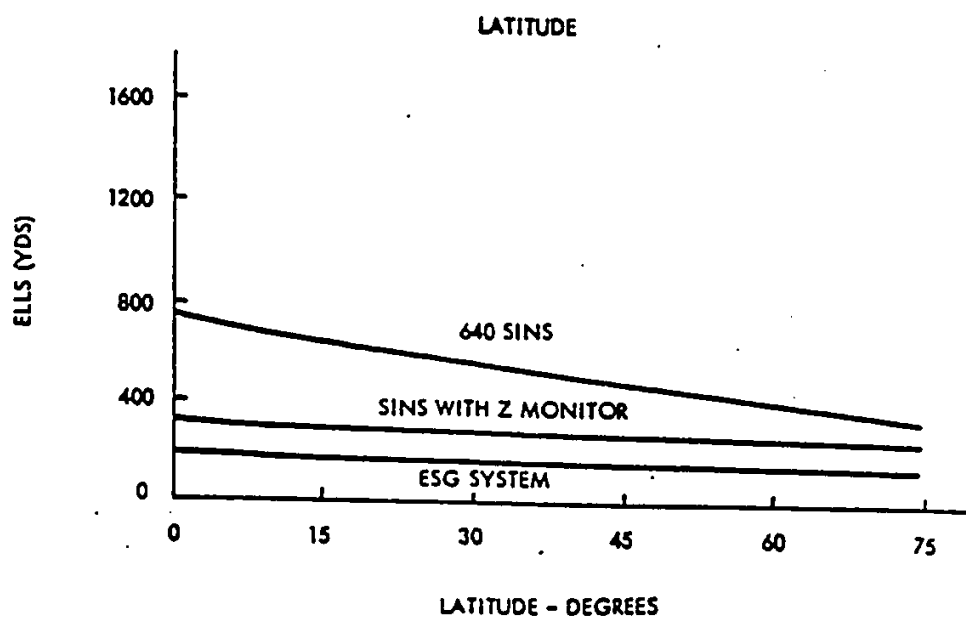

FIX ERROR: 0.1 N.M  
RESET: 5 FIX - 8 HR

Figure 9

SYSTEMS APPRAISAL COMMITTEE DISCUSSION

ADVANCED SYSTEM PERFORMANCE

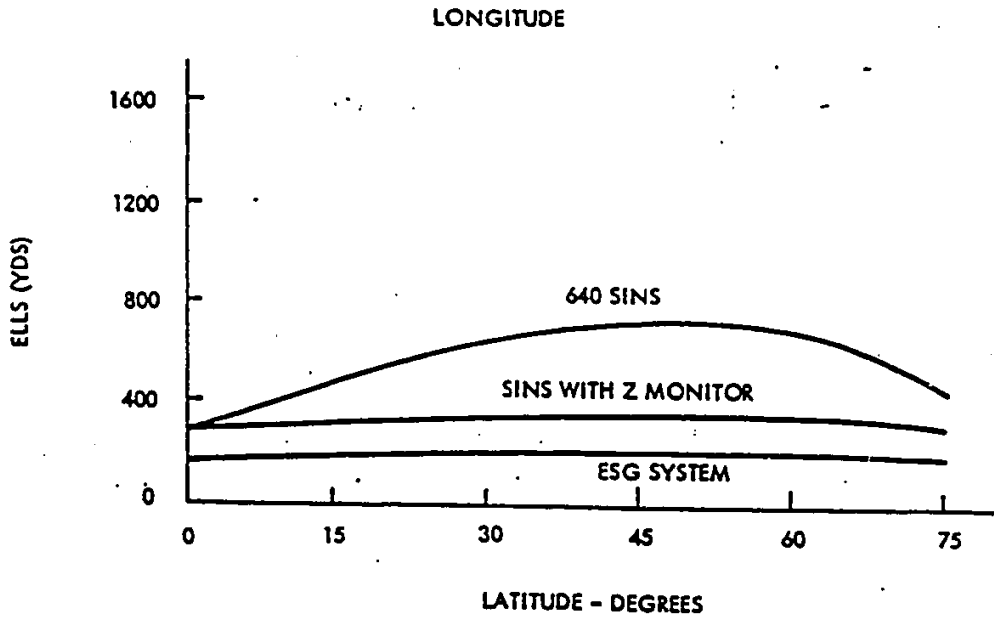

FIX ERROR: 0.1 NM  
RESET: 5 FIX - 8 HR.

Figure 10

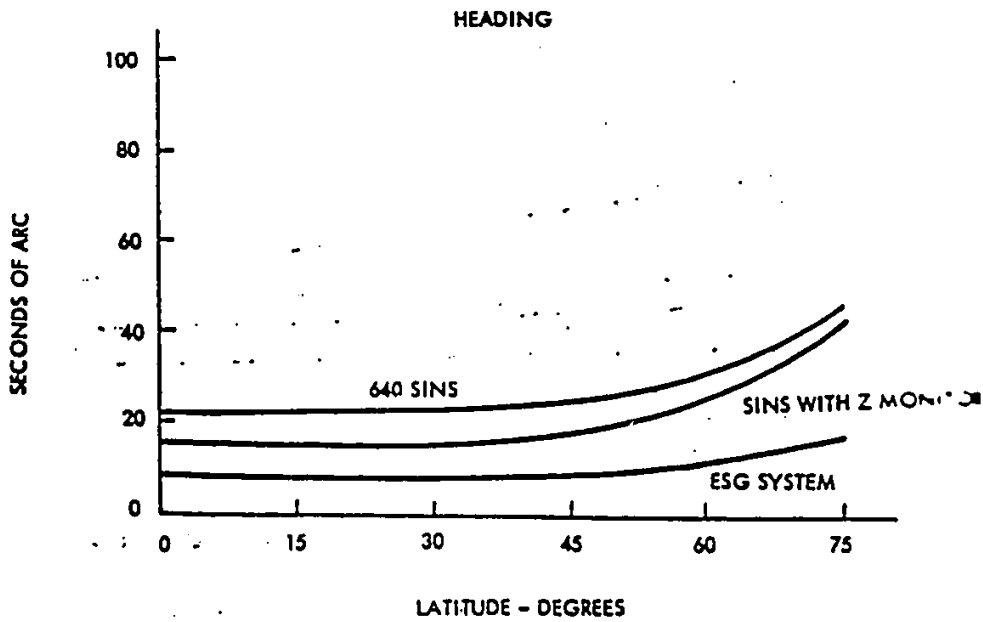

FIX ERROR: 0.1 NM  
RESET: 5 FIX - 8 HR.

Figure 11

## SYSTEMS APPRAISAL COMMITTEE DISCUSSION

"The fix error is cut down to 0.1 n.m., and we have included our figures for a SINS with a Z-monitor accelerometer. The figures may generally be on the optimistic side, but they are indicative of the effect of having a precise azimuth figure aboard the submarine."

Admiral Smith asked about the Z-monitor, and Captain Gooding explained that it is an accelerometer that would supply vertical corrections through a form of reversing technique; at present the device is largely a theoretical assembly of circuits and electronics for the Z-gyro.

"It is simply a device to monitor the Z-axis," said Mr. Cestone, "and it will monitor the vertical with a fourth accelerometer which is in the azimuth gyro platform."

"How much of a change does this mean?" asked Admiral Smith.

Mr. Cestone explained that the device is already in the SINS Mark 3 Mod 3, and Admiral Smith pointed out there were no Mark 3 Mod 3 SINS in the submarines. "I did not ask if this meant the development of another SINS," continued Admiral Smith. "I simply asked if this involved a different SINS. I would like to know what kind of change we are talking about."

"It is only a change in the accelerometer," replied Dr. Craven.

"The technique does not correct for changes or uncertainties in the local gravity, does it?" inquired Mr. Applebaum.

Asked about current equipment, Dr. Craven explained that the SINS Mark 2 Mod 2 does not have this accelerometer.

"And if I may clarify here," said Mr. Cestone, "you are showing us what would happen if we could put this fourth accelerometer into the SINS Mark 2 Mod 2, even though we do not have room to do it."



## SYSTEMS APPRAISAL COMMITTEE DISCUSSION

"Given the chance," observed Captain Gooding, "I think it would be more important to monitor the Z-gyro than the Z-axis per se. With the X-gyro and Y-gyro, we can, through rotation techniques, cancel out a large part of the drift, but we cannot do this with the Z-gyro. We have been trying to figure a feasible method of doing it, but as yet we have not."

"The ESG will not work out as well as you expect," said Mr. Cestone, "because you have the same problem. You are working with a vertical SINS and the ESG monitor does not generate its own vertical but uses the one supplied by the SINS, which only gives you the same problem for both systems."

"I think this is reflected," commented Dr. Craven, "in the conclusions of the committee which estimated latitude and longitude errors at 300."

"Where did you quote this one from?" asked Admiral Smith.

"From an unpublished Sperry report dealing with system improvements," answered Dr. Craven.

"At what point did your forces apply their judgment to that report?" continued Admiral Smith.

"Largely in the conclusion that 300 was as low as we could reasonably hope to go, regardless of the techniques we used," said Dr. Craven. "To summarize this value judgment, if the ESG can be calibrated at sea or is able to hold its calibration at sea, we feel that use of the ESG as an azimuth monitor along with TRANSIT fixes of 0.1 n.m. and a bottom topography system that is as good as the TRANSIT will, in total, give us a navigation contribution of 300 ells in range and 600 ells in track. This is a small drop from our earlier estimate of 400 and 800 ells in range and track."

## SYSTEMS APPRAISAL COMMITTEE DISCUSSION

In response to questions from Admiral Smith, Dr. Craven referred to figures 6, 7 and 8, explaining that the difference in error performance comes in part from the establishment of better azimuth on the latitude and longitude figures.

"Do you have any values on velocity in the advanced system?" asked Mr. Burg. Dr. Craven replied that he had quoted 0.1 n.m.

Mr. Eyestone returned to the point that he doubted that the error figure would improve, as it had been shown to, as the latitudes got higher. Dr. Craven replied that he was not willing to take responsibility for those curves, even though he had studied them at length.

"Is the curve in any way a function of miss distance?" asked Mr. Cestone.

"No, those are statements of actual latitude location," replied Dr. Craven. "I would like to summarize a little on CEP improvements here, shown in figure 12. To make a CEP improvement of any kind, we should first look at the total of our projected possible improvements. For example, improvements in separation and re-entry will bring the CEP down by a certain amount and if they are the only improvements we apply, the CEP will stand at 1200 double cubits. If we apply improvements to fire control and guidance in addition to the improvements in separation and re-entry, the CEP would come down to a conservative 900 ells. If we carry this along and make the navigation improvements, the CEP will come down to a total of 770 ells. My figures are for a 2500-n.m. range. Figures 13 and 14 cover the problem in terms of effort required to implement these changes in the three major areas where we can gain improvements."

"To get some notion of what you mean by major and minor R&D programs," asked Admiral Smith, "how would you classify the development of the A3 missile?"

SYSTEMS APPRAISAL COMMITTEE DISCUSSION

PROJECTED MISS CONTRIBUTION ASSUMING STEP IMPROVEMENTS IN ALL COMPONENTS		
	RANGE	TRACK
SEPARATION & RE-ENTRY	200 ELLS	200 ELLS
GUIDANCE	256 ELLS	301 ELLS
FIRE CONTROL	280 ELLS	250 ELLS
NAVIGATION	300 ELLS	600 ELLS
TOTAL	525 ELLS	780 ELLS
CEP	770 ELLS	

Figure 12

"That is definitely a major R&D program," replied Dr. Cr...  
 "in terms of the missile, but a minor program in terms of required...  
 fit on the submarine. On figure 13 we have two possible programs...  
 in R&D for the re-entry body, but only one result. We did not discuss...  
 too closely here, as most of the committee felt that we could do the...  
 carrying the present guidance system. A minority of the members...  
 out for an alternate path. We did feel the result would be about the same...  
 either way we went."

SYSTEMS APPRAISAL COMMITTEE DISCUSSION

SUMMARY OF REQUIRED R & D AND HARDWARE IMPLEMENTATION TO ACHIEVE CEP GAINS			
ITEM	ADDITIONAL R & D	IMPLEMENTATION BACKFIT	RESULTING CEP @ 2500 N. M.
IMPROVEMENT OF SEPARATION RE-ENTRY SYSTEM	MAJOR IF SECONDARY GUIDANCE SYSTEM IS EMPLOYED - MODERATE TO MAJOR IF PRESENT GUIDANCE IS CARRIED PAST SEPARATION -- MAJOR RE-ENTRY AND FUZING DEVELOPMENT	MINOR FOR SUBMARINE MAJOR FOR MISSILE (REQUIRES NEW RE-ENTRY BODY) WARHEAD MAY BE LESS EXPENSIVE	1230 YARDS (DOUBLE-CUBITS)
IMPROVEMENT OF GUIDANCE AND FIRE CONTROL	MODERATE	MODERATE FOR SSB(N) 616 AND BEYOND	900 YARDS (ELLS)
IMPROVEMENT OF NAVIGATION	MODERATE TO MINOR	MODERATE FOR SHIPS ALREADY CONFIGURED FOR 640 -- MAJOR IF EXTENSIVE BOTTOM BEACON SYSTEM IS EMPLOYED	700 YARDS (ELLS)

Figure 13

SUMMARY OF REQUIRED R & D AND HARDWARE IMPLEMENTATION TO ACHIEVE CEP GAINS			
ITEM	ADDITIONAL R & D	IMPLEMENTATION BACKFIT	RESULTING CEP @ 2500 N. M.
RANGE CALIBRATION	MODERATE FOR 1300 N. M. SLIGHTLY MORE FOR 2500 N. M.	MINOR FOR 1300 N. M. MAJOR FOR 2500 N. M.	LOCATION OF RANGE SHOULD BE ACCURATE TO ABOUT 1/10 CEP TO BE DEMONSTRATED
ATTAINMENT OF 640 CAPABILITY	MINOR	MINOR FOR 6 SSB(N) S MODERATE FOR 21 SSB(N) S MAJOR FOR 41 SSB(N) S	1880 YARDS (DOUBLE-CUBITS)

Figure 14

## SYSTEMS APPRAISAL COMMITTEE DISCUSSION

Mr. Flood asked what was meant by "Moderate for SSB(N)616 and beyond" in the guidance improvement column. Dr. Craven explained that they would propose the removal of the Mark 80 systems here, and a good example of a moderate program would be found in steps to improve the inertial components.

"How about a moderate backfit program?" asked Admiral Smith.

"I think the gyro stabilizer might be a moderate backfit program," replied Dr. Craven. "In navigation we did not feel that there were any really serious problems, and certainly that no major R&D efforts were needed. If the ESG development comes through, the effort should stay at the moderate level. If we started considering ways of monitoring the Z-gyro, the effort could well become major. But navigation has seen steady improvements and right now, we have gyros under development that will provide the required gyro performance."

"The implementation backfit is moderate for ships already set up according to the 640-Class, and somewhat more elaborate for the 627-Class. It gets to be a major effort on the ships of the 598-Class, 608-Class, and 616-Class. It is not just a question of a new SINS system; we feel there is a need for either the ESG monitor or a Z-gyro monitor and the latter choice means a moderately heavy R&D program. The ESG itself, if it works out, will relieve us of that necessity."

"We also consider that navigation improvements should include improved standards on the TRANSIT receiver, such as we may get from the rubidium vapor, and either a bottom beacon transponder receiver or an improved bottom fixing sonar."

Admiral Smith questioned the navigation CEP figure, and Dr. Craven explained that the "700 yards (ells)" on figure 13 is a typographical error, and the figure should be 770 yards.

## SYSTEMS APPRAISAL COMMITTEE DISCUSSION

"In figure 14 we have covered the problems of range calibration," resumed Dr. Craven. "We will have a big job when we face the longer range, as it will be a broad ocean area set-up requiring a great deal of ship time and very elaborate precision calibration. Someone suggested that we use two Pacific islands in the 2500 n.m. range, which would be a major effort by any standards. We do feel that the range should be accurate to 1/10 of CEP to be demonstrated."

"The final entry covers the possibilities of attaining this 640-Class capability. I think these figures need no explanation."

"Where do the limitations lie in the bottom topography system," asked Mr. Eyestone. "Are they in the equipment, or in the very nature of the technique, or in the uncertain nature of the ocean bottom?" Apparently, there is some evidence favoring high accuracy of the transponder."

"The bottom features provide the major inherent limitation," answered Dr. Craven, "with a lesser limitation arising from the beam width."

Asked about lead-time, Dr. Craven explained that his committee did not make any attempt to establish time figures, except for the general assumption that the time would be constrained by the missile development.

"You mentioned several times," observed Admiral Smith, "that you had not looked into the need for your end result. I have a letter from CNO which specifies a need from which we can derive, in different terms, our CEP. It states:

'Provision of a hard target capability which will provide 50 per cent probability of severe damage to point targets hardened to 300 psi.'

For a large warhead -- three megatons -- this would come out to a 0.5 n.m. CEP. In terms of the 1.1 megaton warhead, it means a CEP of 0.4 n.m.

## SYSTEMS APPRAISAL COMMITTEE DISCUSSION

"We also have another paper from CNO which speaks about 20 per cent of the FBM force and another paper which says that 20 per cent of the missiles should have this hard target capability. It is difficult to see whether they mean eight submarines, or a percentage of mixed-load missile submarines, or what."

"I think the idea was to have submarines with a mixed load," replied Commander Clifford. "The statement was based upon the premise that 20 per cent of the targets would require the hard-target capability."

"Using eight submarines with the hard-target load would not answer the problem then," replied Admiral Smith.

"My understanding is that a mix of missiles in the total FBM force is what they desire," said Commander Clifford. "Twenty per cent of the available missiles should have this capability. The CNO letter examined two courses of action to provide this ability."

"I am interested in the distribution," responded Admiral Smith, "in terms of the necessary operational distribution of these missiles. There are many ways by which we could accomplish this, starting with eight submarines and continuing to 41 submarines with many points in between."

"This answer will probably have to go back to CNO," replied Commander Clifford, "for the point of the original communication would be to determine the technical feasibility of the plans suggested in it."

Admiral Smith interrupted further discussion to declare a luncheon recess.

## SYSTEMS APPRAISAL COMMITTEE DISCUSSION

### Afternoon Discussion of the Systems Appraisal Committee Report

Admiral Smith convened the afternoon session by stating that he had talked further with Commander Clifford during the luncheon recess. "I found that, as I expected, putting all these 20 per cent hard-target missiles in eight submarines is not operationally reasonable. On the other hand, although desirable to spread them over all 41 submarines, this is extreme. Quite possibly 20 or 30 submarines would take care of the operational problem. This means backfitting them into the 627-Class and possibly into the 616-Class.

"In any case, as soon as we go to more than eight submarines we are talking about having both A3's and the new missile on the same submarines. This means that we have to have a fire control scheme that can look at either one, or have guidance systems that can be used in both.

"This could be either a modified guidance system or a new guidance system. This then raises the question of backfitting a major portion of A3 missiles. We may then get into complications if missiles for the 598-Class, for instance, are not modified. This could result in the 598-Class requiring its own special A3 missiles."

After further discussion of how such a development would affect backfitting plans, Admiral Smith stated that the CNO letter that he had seen did not mention any time to accomplish this. Questioned by Mr. Foster, Admiral Smith conjectured that such a program would be a deliberate program, as opposed to a crash program, and would probably be seen to be operational about 1970 or later.

Dr. Wilson asked if there were any requirements for penetration aids associated with this.

"The CNO letter says that it is desirable that there also be penetration aids, if feasible," Admiral Smith replied.



## SYSTEMS APPRAISAL COMMITTEE DISCUSSION

"It is my personal opinion that we will not sell a token kind of compromise for ineffective penetration aids to OSD. I think in the light of that, we might look at what would be a reasonable all-over program. Considering that we are talking about an improvement on a system whose general characteristics we will not know until about three years from now, and in view of the figures that Dr. Craven has presented, I personally feel that it would be completely unreasonable to anticipate an accuracy of this sort without essentially all of the changes that Dr. Craven has talked about.

"A 3-megaton warhead," continued Admiral Smith, "reduces our range down to about 1500 nautical miles."

"Yes," agreed Commander Julian, "that assumes you can build the 3-megaton system in a 1550-pound total re-entry system weight."

Admiral Smith asked if a 1500-n.m. range changed the CEP figure.

Dr. Craven replied that about 0.8 is a rule of thumb multiplier between the figure he gave for 2500 and for 1500 n.m.'s. So, if you have 0.5 n.m. CEP at 2500, you have about 0.4 n.m. CEP at 1500.

"Then, the 770 ells in figure 13 would move up to the next to the last category in place of 900 ells," stated Admiral Smith.

"That is right," concurred Dr. Craven. "You would have a better chance to get that half mile."

"Is this certain enough to justify knocking off that last item improvement of navigation?" asked Admiral Smith.

"Yes, I do not think you buy that much with the last navigation alternative," Dr. Craven answered. "If you move to 1500 n.m., say 1000 yards is a good figure in place of the 1230 double curvature."

## SYSTEMS APPRAISAL COMMITTEE DISCUSSION

"Do you really expect to get half a mile?" Admiral Smith inquired. "I am not talking about theoretical possibility or something else, but where your reputation is at stake."

"Then," replied Dr. Craven, "I would use the upper limit which is certainly less than 1200 yards."

"Using 1200 yards, then, we are talking about both improvement of re-entry systems and improvement of guidance and fire control for the desired accuracy," Admiral Smith stated. "Under those circumstances do we want to question Dr. Craven's judgment that it is not worth putting in the stellar tracker?"

"As I said, I think it is a tradeoff right now," continued Dr. Craven, "and my value judgment is that it is not worth it."

"One way we have been looking at putting in the star azimuth corrector," stated Mr. Forter, "is to put it on the stub shaft of the guidance system as a relatively independent piece so that if it does not work we can take it off without upsetting the rest of the system. It has to be a lot better than navigational azimuth or it is not going to do any good."

Dr. Craven said that it looked as though navigational azimuth would be accurate to about 30 seconds at that scale.

"We are going through a thorough analysis of what the tradeoff point is in terms of navigation azimuth versus stellar corrected azimuth," Mr. Forter continued. "It looks as though it is very much in the neighborhood of what Dr. Craven is talking about."

"I would like to propose," said Admiral Smith, "that we try to put together some kind of guide lines for the major features to be included in a study as the starting point for the features that Dr. Craven has pro-

## SYSTEMS APPRAISAL COMMITTEE DISCUSSION

posed in the first two items of figure 13. I would like to ask for a report to be distributed to the STG members about a month from now, and then a special meeting to go over the report a week later."

"This assumes that you have to do it with the A3 missile," said Mr. Morton.

"Yes," Admiral Smith replied.

"Are the dispersions in the A3 re-entry greater than they are in the A2 because of different separation mechanisms for the re-entry body?" continued Mr. Morton. "What we are talking about here is the same range as the A2 and there is 0.1 n.m. difference in accuracy for the same effect. You are carrying a 1.1- versus a 3-megaton warhead."

Mr. Morton said that by an accuracy difference of 0.1 n.m., the two systems could be made comparable.

"You cannot do it without putting the guidance system in the re-entry body," Mr. Forter claimed.

"The reason for putting a guidance system into the A3 head," said Mr. Morton, "is to get the separation inaccuracies reduced. You do not have the same separation problems in the A2."

Dr. Craven said that the same or greater uncertainty existed in the air spring used for A2 re-entry body separation.

"This is the point I am making," replied Mr. Morton. "It is not clear that you have the same separation inaccuracies on the A2 system that you have on the A3. In fact, Lockheed told us that we did not. You have one particular spring problem but you do not have all the thrust changes."

## SYSTEMS APPRAISAL COMMITTEE DISCUSSION

Mr. Forter replied that in the A2 system there is a thrust termination uncertainty, while Dr. Craven noted an additional uncertainty in the air spring.

"You are telling me now that the separation problems in the A2 are comparable and cause the same errors as in the A3?" Mr. Morton asked.

"Yes," said Dr. Craven, "as a single warhead."

Mr. Morton did not concur because of additional factors in the A3 separation, such as misalignment of the rocket, variations in the rocket, and the second stage fly-by.

"There is a report which outlines the attempt to look at the plus velocity due to the A2 air spring," Dr. Craven said. "If you look at that, you really get some notion of the tremendous uncertainty that is involved."

"I think Mr. Morton's point is reasonably valid," Mr. Peterson interceded, "on the basis that the A2 separation may be mechanically solvable whereas the A3 separation may not."

"In trying to improve the separation characteristics," said Mr. Gibson, "you are working on the 0.1 n. m. that is the hardest to get."

"Mr. Morton's point is that it might be quite worthwhile to take a look at it as a tradeoff," Mr. Peterson reiterated. "It may be the toughest one to get, but you may be able to get it without too many major changes if you can solve the mechanics of the problem."

"The fire control guidance change," Mr. Morton continued, "amounts to two things, primarily in terms of mechanical hardware. One is the resolver system for the alignment and the other is the change of the bit size in the computation."

---

## SYSTEMS APPRAISAL COMMITTEE DISCUSSION

"I do not agree with you on that," said Mr. Forter. "We just did some work on that last week, adding one more bit and putting bits in the resolver, making a total reduction in CEP of something like six or seven yards."

"What else are you going to do then?" asked Mr. Morton. "The other things that have been suggested are not hardware changes as such. As you indicate on the chart, you are already putting in improved guidance capsules."

"The other part is the transmission from SINS to fire control and fire control to guidance by means of analog, which is mentioned in the BULLSEYE Report," stated Mr. Forter. "We are not going to a digital resolver or increasing the word length. We can accomplish a great deal without doing that by improving the transmission characteristics."

"We are trying to decrease the 10-second error in the resolvers," Mr. Burg said, "but I doubt that we will get below that figure."

Mr. Forter stated that the biggest error still occurred from SINS to fire control to guidance.

"These are the two things which determine compatibility," said Mr. Morton, "and you are going to change all the other things with growth. The improved components are just evolutionary types of things. The only two things which affect compatibility are the guidance capsule and the digital bit size. I am referring to paragraphs 16.a and 16.b on page 6 of the Systems Appraisal Committee report."

"Item 16.c does not affect compatibility at all," Mr. Forter claimed. "This requires new computer programming. Taken together, item 16.b does not affect compatibility either."

"This is true with respect to the current Mark 2 guidance system," Admiral Smith agreed. "Now, how about the guidance items?"

## SYSTEMS APPRAISAL COMMITTEE DISCUSSION

"The clock change is quite minor and does not affect anything except the computer; it is on the way," Mr. Forter began. "The growth plans for it and the change in the quantization still need more work, but the indication is that it does not improve overall system performance very much, and the round-off error in the computer is purely for the control program."

"You are right in terms of the fire control and guidance," replied Mr. Morton, "but the point was that you can not effectively use the improved velocity that we could give you from navigation unless you do that. In other words, the quantization, as such, does not affect the fire control guidance loops unless you can do something about using the improved velocity that you get from navigation."

"The analysis was made on the basis of 0.5 knot velocity," answered Mr. Forter, "and if the velocity does go down to the bit size and bit rate you are still helped. If you go beyond that you are only helped a little. If the velocity improves to a point so that it is comparable to the bit size in the computation in fire control and guidance, you have gained much more than you have by going a little further and then decreasing the bit size."

Mr. Flood replied, "There is one area where bit size is very important, and that is with the analog to digital converter. We only have a 9-bit converter in the erection loop and there should be a significant improvement made in that area which does not change the fundamental size of the fire control. This is an improvement that could be made was not required when we worked on the Mark 84. Going from a 9-bit to a 13-bit analog-to-digital converter presents technical problems, but, I say it could be done."

"The change in the computer from the present to the possible does not accomplish much when you RSS it," stated Mr. Forter, "the gyro and accelerometers then become quite comparable to the analog computer."

## SYSTEMS APPRAISAL COMMITTEE DISCUSSION

"The thing that I was trying to get across was that you can do these things without worrying about compatibility," Mr. Morton reiterated. "The two things which require worrying about compatibility are alignment loop and bit size. One problem we have is that the range impact measurement must be improved if you want to know how accurate the shot was; the whole problem of knowing what the contributions to the error are requires improvement in instrumentation."

"I would like to address the problem of what the tradeoff is if we have a 30-second azimuth from navigation," said Mr. Flood. "If we do not change to the system mentioned by Dr. Craven, we would have about 10 seconds resolver error in fire control and 10 seconds in guidance in addition to the navigation error. We have to RSS those three. On the other hand, if you change to the system proposed in Dr. Craven's report, you have 30 seconds error in navigation, no error in fire control because it is done in the DGBC to an accuracy greater than we are talking about, and 5 seconds in guidance due to resolver transmission."

"It is still an analog resolver that you convert to digital," answered Mr. Forter, "so you have the 10 seconds fundamental in the analog resolver before you convert to bits."

"RSSing 30, 10 and 10, or 30, 5 and 5, gives you 33.2 seconds and 30.08 seconds," said Mr. Flood. "The factor is about 25 yards in cross range per second of azimuth."

"I would like to point out that azimuth is the big thing that is still biting you," stated Dr. Craven. "Three or four seconds of azimuth is not insignificant."

"It is a question of how you add it together with all the bigger azimuth errors that are involved," said Mr. Burg.

"The way you saw it in figure 5 is the way it added up," Dr. Craven answered. "If you want to look at each part you may convince yourself that each part is not making much change, but that is the way it added up."

SYSTEMS APPRAISAL COMMITTEE DISCUSSION

"Looking at figure 5," said Mr. Burg, "it is not the alignment error that is bothering me so much in the present system, as the gyro and accelerometer errors."

"If you look at the alignment error source in the present fire control," Dr. Craven said, referring to figure 15, "you are left with 465 yards in track which is now a major contribution; that is 465 yards to be RSSed with other track errors."

"The way we have been calculating it is to pull out all of the azimuth as a separate function," interjected Mr. Forter, "and then take the alignment azimuth out of the guidance and put up a separate alignment. You have all of the azimuth as another error; instead of having guidance, fire control, and so on, you have azimuth. As long as there are 30 seconds of navigation azimuth error, going from 10 to 5 only changes the error about 100 yards."

"We are looking for a total CEP of 800 yards," Admiral Smith stated, "and we are not going to settle for less. Each one of these things may be insignificant, but each contributes."

"Figure 15 shows errors for both guidance and fire control together," continued Dr. Craven. "What you must do, however, is look at the lead contender because it will always dominate your results."

	PRESENT		POSSIBLE	
	R	T	R	T
ALIGNMENT	0	465	0	189
ERECTION	0 142	475 44	0 108	278 25
INITIAL VELOCITY	361	24	238	16



## SYSTEMS APPRAISAL COMMITTEE DISCUSSION

Mr. Forter suggested that they look first in fire control, leaving the basic bit a 0.25 fps. Asked about velocity, Mr. Flood observed that bit size was the least error in initial velocity and that others, like the Q-round-off of the 0.5 knot, were more important.

"At 0.5 knot, bit size means nothing," said Dr. Craven, "but if you can send through 0.1 knot, as the SSB(N)G40 promises, then bit size makes a big difference. The 0.1 knot is an improvement in both velocity and the erection look, but unless we are digitalized, it is of no use to us. I agree that each area provides only small improvement. When totaled, however, we will find that the initial velocity and the erection look will hurt most."

"We have not reviewed this completely," said Mr. Peterson, "so we will need a month to give you an honest answer. We started discussing whether we could get that 1500-mile range by altering a missile we have, or whether we would need a whole new missile, or at least a new front end. From what little I have heard -- and I do not know much about this except that I obviously have two schools of thought in my own company -- it seems to me that there is a fighting chance we might be able to make it with the A2."

The committee was reminded that some sort of rocket had to be added to the A2 re-entry body if a guidance package was to be placed in the front end.

"Trying to trim from 0.5 n.m. to 0.4 n.m. is like making an order of magnitude change in one of the systems for improvement in error," said Mr. Burg, "and I do not know how you are going to do that."

"There is no magic way," said Mr. Flood, "You have to fight every error."

"How would the A2 get down to 0.5 n.m.?" asked Captain Sanger.

SYSTEMS APPRAISAL COMMITTEE DISCUSSION

"You have to redesign and put in a high speed re-entry system, but still have it weigh less," replied Commander Julian. "Therefore the range will probably be high, and you are trying to get 0.4 n.m. at 2000 n.m. "

"When you get this high speed re-entry system, it is not going to fit in the tube," said Dr. Wilson.

"This one is 18 inches, and 11.6 inches in critical diameter," agreed Commander Julian.

"I am not sure that the diaphragm should not be a permanent constraint," said Dr. Mechlin. "Six inches would be squeezed out with considerable difficulty there."

"Have you looked at 1000 W/C<sub>D</sub>A with a Y2 warhead?" asked Admiral Smith.

"No, sir," answered Commander Julian, "we have not, but we will."

"Just how much increase in length are we talking about?" asked Admiral Smith. "This certainly would involve a Mark 2 guidance system."

"With the A2 missile," replied Commander Julian, "I think we are well below 1500 miles immediately, using a re-packaged Y2 Mark 2. Maybe I misunderstood; we are not talking about putting the Mark 2 re-entry system or body on top of an A3 missile."

"No, we are talking about 1000 W/C<sub>D</sub>A Mark 47 Y2 on an A3 with Mark 2 guidance," stated Admiral Smith.

"By adding a new equipment section," said Dr. Wilson, "you are getting close to a new missile. When you have 1000 W/C<sub>D</sub>A in or out, make it stay, you have to make a larger base diameter at the attachment than we have right now."

## SYSTEMS APPRAISAL COMMITTEE DISCUSSION

"I think we are already up to about a 1100-pound re-entry system," stated Commander Julian. "If we are talking about penetration aids, we are down to 1500 n.m. immediately. Without penetration aids you could possibly get close to 1500 n.m. I am using the same ratios in this that we have in the new cone sphere system, where a 3-megaton warhead in a bare system purports to weigh about two-thirds of the total re-entry system weight. Now, going back to the Mark 47 and the Mark 1 re-entry system, it would weigh around 1100 pounds or so if we take it up to 35 per cent. We might have to ballast this so heavily to get stability that there would be considerable increase in weight. We have an 18-inch critical diameter, which is the cylinder diameter."

"Were we not talking about a net 200-yard missile contribution outside of guidance?" asked Captain Sanger.

"Not at 2500 n.m.," answered Dr. Craven. "To get 1000 ells you need that 200-by-400 but when you get down that low it is below the noise; so if you have 400-by-400, you will still be all right."

"We have to design a warhead that will not contribute any more than 400-by-400 on re-entry, including the attitude of separation," stated Mr. Morton.

"Then you have to put in the navigation improvement," replied Mr. Flood.

"That change is coming anyway in the 640 system," Dr. Craven continued. "Navigation will start to submerge anything which is 300-by-300, or certainly 200-by-200. Perhaps I will retract a little from the 400-by-400 figure; that would really start to show. However, 200-by-300 would not really show."

"I am a little reluctant to ask for both of these studies in the same period," said Admiral Smith. "If we go just a little bit over time, we will slip a year and come out with nothing."

## SYSTEMS APPRAISAL COMMITTEE DISCUSSION

"Can we just assume that they give us a warhead that they already have and see what the dispersion is on the Mark 47 Y2 version?" asked Mr. Morton.

"Would you include a change in the current separation system?" questioned Captain Sanger.

"I would like to take out the spring effect because this is not an error," said Mr. Morton. "It is just not known."

"The measurements that we do have do not show comforting variations," replied Dr. Craven. "The report gives 0.53 foot per second sigma and this, in my view, is not empirical evidence. That is a simulated value obtained from measurements which are not entirely certain, such as the force with which the re-entry body is held on."

"The forces do not come into it," said Mr. Morton. "It is an issue of the instruments used in measuring and how accurate the final measurements are; I could have zero force and your measurements could be so gross that you could not tell it."

"I am familiar with the ground tests," countered Dr. Craven. "You calibrate the variation in the force it takes them to separate, and this gives you the 0.53 foot per second sigma. However, the measurements give you the feeling of 2, 3, or 4 feet per second sigma, which would result in about 830 yards per foot per second."

"Is there any doubt that you would need a high  $W/C_D A$  in order to get that part of it down?" Dr. Wilson asked.

"There is no doubt in my mind," answered Dr. Craven.

"You will have to reach supersonic impact," said Dr. Wilson. "It is when you go transonic that it becomes bothersome, so if you are

## SYSTEMS APPRAISAL COMMITTEE DISCUSSION

not talking about 1000 you are talking 850 or thereabouts. If you remember the old JUPITER design, they had something like 700 or 800, and their wind dispersions were nearly the same as ours because of the transonic and subsonic drag that they got. You have to get over that one hurdle. Just changing it from 200 to 400  $W/C_D A$  does not mean very much."

"What if we set as a secondary study objective, not to interfere with meeting the primary study objective, looking at the weight and dimensional implications of repackaging the A2 without the PX?" Admiral Smith proposed.

"May we ask Commander Clifford about the OPNAV opinion on when this system should be operational?" asked Commander Julian.

"Let me clarify one thing first," replied Admiral Smith. "The opinion I offered was on a feasible required operational date. Now, with that clarification, go ahead."

"The general idea of the proposal was, of course, the sooner the better," began Commander Clifford. "We thought in terms of four to five years but we did not know how long it would take. The earliest we could predict this would happen in the PCP system was 1965. You were going to do it in about 4 years on the B3, and we assumed that it would take about the same time."

"How do Lockheed and MIT feel about coming up with a useful study of the guidance, separation, and third-stage propulsion study in the time period I proposed?" asked Admiral Smith.

"I believe we can have a reasonable study completed in a month," replied Dr. Wilson.

---

## SYSTEMS APPRAISAL COMMITTEE DISCUSSION

"What we need is a study that will enable us, after a few days of review, to prepare a change proposal involving not only the development but also the other implications such as backfit and production," said Admiral Smith.

"I was thinking in terms of a feasibility study," said Dr. Wilson. "If you are talking about a program change notice, you will want costs and time spans for development. You will need to be fairly certain what the system will be before you can do that kind of work."

"In other words," said Mr. Parran, "this study is to answer the question of how to go 1500 miles with 3 megatons, allowing for a 0.5 n. m. CEP."

"This is with consideration given to re-entry body, guidance and fire control," reiterated Admiral Smith.

"Do you want to nail that down to 3 megatons?" asked Captain Sanger.

"We started last week on the basis of the 3 megatons with the A3," said Mr. Forter.

"That is correct," replied Admiral Smith. "I am not talking about a whole technical development program; that will come later."

"I am presuming that the secondary study will not be in terms of cost and programming," said Mr. Gibson, "but that it will be concentrated on the technical side."

"Yes," continued Admiral Smith, "and if that one worked, it would be much easier to substitute. You would not need to complete a study."

"We can come in with something," replied Mr. Gibson, "but I do not know how much confidence I will have in it."

## SYSTEMS APPRAISAL COMMITTEE DISCUSSION

"We should look at this on the basis of 23 SSB(N)'s that would have A3's for the 20 per cent mix," said Mr. Forter.

"That only gets into the magnitude of the backfit," Admiral Smith stated.

"It means that you have one 616-Class ship for the fire control," replied Mr. Forter.

"Fire control really does not make much difference," Admiral Smith pointed out. "The big difference in these classes is navigation."

"Does it make any difference with respect to the firing rate?" asked Captain Sanger.

"If you fix each channel until you get each missile, you can fire at the right rate," said Mr. Burg.

"This approach will work if you do not change the channel," Mr. Forter added.

"You cannot shift channels," replied Mr. Burg. "In other words, if one channel fails, you have had it. All you can do is fire all of one type of missile and then shift the targets onto the other computer. If the ballistics are very different between two missiles, you cannot accommodate them in a single program and you have to use more computers per missile."

"You will end up splitting the system into two lobes, really," said Dr. Craven.

"Then could you switch back and forth just by changing the program?" Mr. Forter inquired.

## SYSTEMS APPRAISAL COMMITTEE DISCUSSION

"You could," replied Mr. Burg, "if the two missiles are not different. You could either interlace them or put a small auxiliary program in each computer. However, from what I have heard so far, I do not think we will have two missiles that will accommodate this."

"There are other ways to approach this problem," said Mr. Flood. "If you did not try to include SUBROC and missile fire control in the same solution, you could have two programs completely independent of the fire control."

"That ought to be looked into," said Admiral Smith.

"It would definitely handle both programs," added Mr. Flood.

"We have almost saturated the computer memory already with the SUBROC program and the existing Mark 84 ballistic program, for whichever missile you want to take," continued Mr. Burg. "It is not a question of manning the SUBROC program, actually; it is a question of keeping track of what targets are around you in case you have to stop firing missiles and assume a different mode of operation, such as defending yourself. Then you are in a position to do so almost immediately. If you eliminate the SUBROC program, however, you can probably handle two types of missiles."

"We are not considering eliminating it from the picture," corrected Admiral Smith. "We just want to eliminate the requirement that both be done simultaneously."

"This would impose a hardship only if you said you had to compare two different kinds of geo-ballistics, such as an A3 with three warheads and an A3 with one warhead," concurred Mr. Flood. "I see no hardship, under the present circumstances."



## SYSTEMS APPRAISAL COMMITTEE DISCUSSION

"Admiral, what shall we assume will be filling up the rest of the tubes in these 23 SSB(N)'s?" asked Mr. Parran. "Will you have Mark 1 and Mark 2 guidance systems in the same submarine?"

"No," replied Admiral Smith. "We will have Mark 2 and Mark 3 guidance systems or whatever you come up with."

"That means that your Mark 3 had better look a little like the Mark 2," stated Mr. Peterson. "Otherwise you will have some trouble."

"Mr. Forter would have it look just like a Mark 2," interjected Mr. Parran.

"We still have another problem to handle," said Mr. Burg. "If there are significant differences in the things that we have to monitor in these missile, the MTRE's in them have to be different. There will also be a problem if there are any significant parameter differences in the things that you have to look at during the time you are counting them down."

"Anything that would require a tape change would create further problems," added Mr. Gibson.

"What is the probability of this happening," asked Admiral Smith, "if we are talking about two missiles that are the same except for the equipment sections?"

"They may not be substantially different unless we have some differences in timing for battery initiation and things like that," replied Mr. Burg.

"If you are considering as big a change as we are talking about," said Dr. Wilson, "I doubt that you will wind up with the same flight control filters, for example, because you would be changing your primary structure of the missile. If we are not careful we could readily get into a compatibility problem for automatic checkout equipment as well as countdown equipment. If you are going to check out the first stage control system, it is going to be difficult. You will also have a star control tracker."

## SYSTEMS APPRAISAL COMMITTEE DISCUSSION

"I do not see how we can get around this problem that Mr. Burg has raised," said Admiral Smith. "This involves modules in the MTRE's."

"Fortunately, we do have two MTRE's," continued Mr. Burg. "The problem is that if we get to the same point we did with the DGBC's, where we had two basic programs so different that we could not keep them in the same computer, we will have to channelize them."

"Do different flight control constants and guidance checks make the operational modes that different?" asked Captain Sanger. "After all, all you do in the operational mode is start up the missile, activate the batteries, shift to internal power, and make sure you have indexed. I do not see how this will have to change."

"There are additional battery power supplies that you have to take care of because of changes in the upper end," replied Mr. Burg.

"The idea is to make them look alike," added Mr. Forter. "If they do not, however, we will exploit the two MTRE's."

"Let us set a guide line that it is acceptable to use the two MTRE's different if necessary, and accept whatever reduction of launch reliability that results," said Admiral Smith.

"Does the same statement hold for dual channel operation of the fire control?" asked Mr. Peterson.

"Yes, except that we should plan to use the SUBROC capacity for this operation," continued Admiral Smith, "provided, of course, we can use SUBROC both immediately before and shortly after the missile firing."

"One thing that should be made clear in our preliminary discussion is that the guidance system provides 800 cycles for the autopilot," stated Mr. Forter. "Since the guidance system leaves the autopilot, we will need another source for this 800 cycles after separation. We will need to leave one autopilot behind and take one with us."

## SYSTEMS APPRAISAL COMMITTEE DISCUSSION

"We also need a study of the range problem," said Dr. Craven. "One of our recommendations was that this system would not be useful unless the range problem is resolved."

"You mean just the location of the Antigua MILS?" asked Admiral Smith.

"Yes, if we are talking about 1500 miles, the location of the MILS," replied Dr. Craven.

"This report should deal with the technical approach -- a description of the backfit program," Mr. Parran said. "How far do you want it to go in the direction of what to do, how long it would take, and what it would cost?"

"As much as you can get in a month," answered Admiral Smith.

"Did you say we should look at PX if possible?" asked Dr. Wilson.

"If we continue with the design as intended," replied Commander Julian, "we will not carry any in the missile anyway. Perhaps we can arrange an ejection sequence so that it does not perturb the separation kinematics further. Perhaps PX could be considered separately from the accuracy problem, and made a range perturbation problem only."

"As far as the guidance system is concerned, how open minded are you about any change from the Mark 2 as long as it would preserve the fire control-guidance missile interface?" asked Mr. Forter.

"That is part of the exercise," reiterated Admiral Smith.

"I think the Admiral would also say that the goal is not to make the most possible changes but to make the fewest," added Mr. Peterson.

## SYSTEMS APPRAISAL COMMITTEE DISCUSSION

"Does this presume the 400-yard location error and the 30-second azimuth error for navigation?" asked Mr. Forter.

"It does," replied Dr. Craven, "and I was wondering whether the navigation people would want to have an opportunity to comment. Captain Gooding, what do you think about the figure we gave of 400, 400, 30 seconds, and 0.1 knot?"

"I think we can do it," answered Captain Gooding.

Admiral Smith requested Captain Gooding to prepare a report of what would be necessary to bring the G16- and G27-Classes up to that performance level.

"In general," Admiral Smith concluded, "the over-all study should include what you think will get us 800 yards CEP: fire control, guidance, guidance in the re-entry body, vernier third stage (just enough to use the guidance information). You may include or omit the star tracker for use during that same period."

In further discussion it was decided that all reports shall be in SP by 22 April and a special meeting will be held in SP to discuss the reports on 26 April.